

Vertical Energy Storage System

SR-EOV24 Series

EOV24-5.0S-S1 EOV24-10.0S-S1
EOV24-5.0U-S1 EOV24-10.0U-S1

Long life and safety

Vertical industry integration ensures more than 5000 cycles with 80% DoD.

Easy to install and use

Integrated inverter design, easy to use and quick to install. Small size, minimizing installation time and cost Compact and stylish design suitable for your sweet home environment.

Multiple working modes

The inverter has a variety of working modes. Whether it is used for main power supply in the area without electricity or backup power supply in the area with unstable power to deal with sudden power failure, the system can respond flexibly.

Fast and flexible charging

A variety of charging methods, which can be charged with photovoltaic or commercial power, or both at the same time

Scalability

You can use 4 batteries in parallel at the same time, and can provide a maximum of 20kwh for your use.

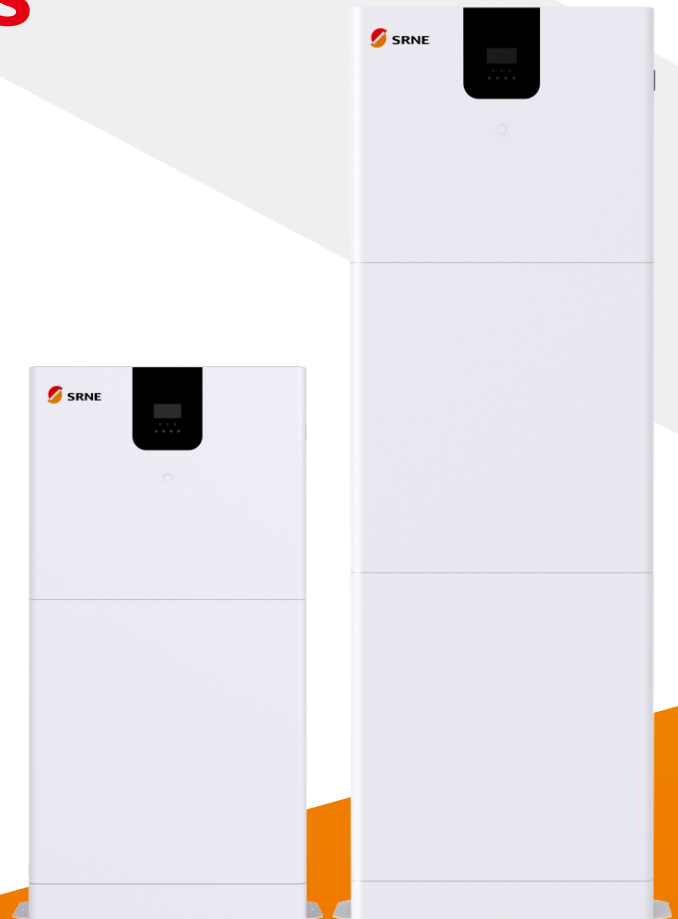

Application scenario >>>



Product parameters

	SR-EOV24-5.0S-S1	SR-EOV24-10.0S-S1	SR-EOV24-5.0U-S1	SR-EOV24-10.0U-S1
BATTERY TECHNICAL SPECIFICATION				
Battery model	SR-EOV24-5.0A-E1			
Number of batteries	1	2	1	2
Battery Energy	5.12kWh	10.24kWh	5.12kWh	10.24kWh
Battery Capacity	200AH	400AH	200AH	400AH
Weight	100kg	170kg	100kg	170kg
Dimension L x D x H	1190x600x184mm	1800x600x184mm	1190x600x184mm	1800x600x184mm
Battery Type	LiFePO4			
Battery Rated Voltage	25.6V			
Battery Working Voltage Range	22.4 ~ 28.8V			
Maximum Charging Current	150A			
Maximum Discharging Current	150A			
DOD	80%			
Designed Life-span	5000			
INVERTER TECHNICAL SPECIFICATION				
INVERTER MODEL	SR-EOV24-3.5S-C1		SR-EOV24-3.5U-C1	
PV CHARGE				
Solar Charge Type	MPPT			
Maximum Output Power	4000W			
PV Charging Current Range	0~80A			
PV Operating Voltage Range	120~500V			
MPPT Voltage Range	120~450V			
AC CHARGE				
Maximum Charge Power	2240W		1120W	
AC Charging Current Range	0~80A		0~40A	
Rated Input Voltage	220/230Vac		110/120Vac	
Input Voltage Range	90~280Vac		90~140Vac	
AC OUTPUT				
Rated Output Power	3500W			
Maximum Output Current	30A		40A	
Frequency	50Hz		60Hz	
Overload Current	35A		45A	
BATTERY INVERTER OUTPUT				
Rated Output Power	3500W			
Maximum Peak Power	6000VA			
Power Factor	1			
Rated Output Voltage (Vac)	230Vac		120Vac	
Frequency	50Hz		60Hz	
Auto Switch Period	< 15ms			
THD	< 3%			
GENERAL DATA				
Communication	RS485/CAN/WIFI			
Storage time / temperature	6 months @25°C;3 months @35°C;1 months @45°C;			
Charging temperature range	0~45°C			
Discharging temperature range	-10~45°C			
Operation Humidity	5% ~ 85%			
Nominal Operation Altitude	< 2000m			
Cooling Mode	Force-Air Cooling			
Noise	60dB(A)			
Ingress Protection Rating	IP20			
Recommended Operation Environment	Indoor			
Installation Method	Vertical			
Certification	UN38.3,MSDS,EN55032,EN55024,EN61000-3-2,EN61000-3-3			

SR-EOV24 Vertical Energy Storage System

User Manual

V1.2



1. Instructions

Thank you very much for choosing the SR-EOV series household energy storage system developed and produced by our company. Please read and understand all contents of the Manual carefully before installing and using the product. If you have any suggestions during the use, please do not hesitate to give us feedback.

1.1 Range of Application

The installation and user manual of SR-EOV series is applicable to the installation and use of the following products:

No	Applicable to the countries with 220V mains voltage	Applicable to the countries with 110V mains voltage
1	SR-EOV24-5.0S-S1	SR-EOV24-5.0U-S1
2	SR-EOV24-10.0S-S1	SR-EOV24-10.0U-S1
3	SR-EOV24-15.0S-S1	SR-EOV24-15.0U-S1
4	SR-EOV24-20.0S-S1	SR-EOV24-20.0U-S1

The product should be used in compliance with local standards, laws and regulations, because any non-compliance with the use may lead to personal injuries and property loss.

The drawings provided in this Manual are used to explain the concepts related to the product, including product information, installation guide, electrical connection, system debugging, safety information, common problems and maintenance, etc.

The internal parameters of this product have been adjusted before delivery. No internal parameters can be changed without permission. Any unauthorized changes to the settings will invalidate the warranty, and the Company will not be liable for any loss resulting therefrom.





This Manual and other related documents are an integral part of the product and should be kept properly for onsite installation personnel and related technical personnel to consult.

1.2 Meaning of Abbreviations

AC	Alternating Current
DC	Direct Current
PV	Photovoltaic
BMS	Battery Management System
PCS	Power Conversion System
RJ45	Registered Jack 45
SOC	State Of Charge
C	Charge C-rate
RS485	RS485 Communication Interface
CAN	Controller Area Network

1.3 Symbol Stipulations









There may be following symbols herein, and their meanings are as follows.

Symbols	Description
	Indicate a hazard with a high level of risk which, if not avoided, will result in death or serious injuries.
	Indicate a hazard with a medium level of risk which, if not avoided, could result in death or serious injuries.
	Indicate a hazard with a low level of risk which, if not avoided, could result in minor or moderate injuries.
	Warning information about device or environment safety. If not avoided, equipment damage, data loss, performance degradation or other unanticipated results may be resulted in. The "NOTICE" does not involve any personal injuries.

2 Safety Precautions

2.1 Safety Symbols

This product contains the following symbols, please pay attention to identifying.

Symbols	Description
	Observe enclosed documentation
	Danger. Risk of electric shock!
	Danger of high voltages. Danger to life due to high voltages in the Energy storage system
	Hot surface
	CE certification
	Do not touch the product in 5mins after shutdown
	Comply with RoHS standard
	The Energy storage system should not be disposed together with the household waste.

2.1 General Safety



2.1.1 Important Notice







Before installing, operating and maintaining the device, please read this Manual first and follow the symbols on the device and all the safety precautions in this Manual.

The matters indicated with "DANGER", "CAUTION", "ATTENTION" and "NOTICE" in this Manual do not represent all the safety matters to be observed, but are only the supplements to all the safety precautions. The Company will not be liable for any violation of general safety operating requirements, or any violation of safety standards for the design, production and use of the device. The device must be used in an environment that meets the requirements of the design specifications. Otherwise, the device may fail, and the abnormal device function or component damage, personal safety accident, and property loss arising from this are not covered within the quality assurance scope of the device. When installing, operating, and maintaining the device, the local laws, regulations, and codes shall be followed. The safety precautions in this Manual are only supplements to local laws, regulations, and codes. The Company shall not be liable for any of the following circumstances.

- The device is not run under the conditions of operating described in this Manual.
- The installation and operating environment is beyond the requirements of relevant international or national standards.
- The product is disassembled or changed, or the software code is modified without authorization.
- The operation instructions and safety warnings related with the product and in the documents are not followed.
- Damage of the device is caused by abnormal natural environment (force majeure, such as earthquake, fire, and storm).
- Transportation damage is caused during customer's own transportation.
- The storage condition does not meet the requirements of the product related documents and causes damage.

2.1.2 General Requirements

	<p>Operating when the power is on is strictly prohibited during installation.</p>
	<p>It is strictly prohibited to install, use, and operate any outdoor equipment or cables (including but not limited to transporting equipment, operating equipment and cables, plugging and removing signal ports connected to the outdoor, working at altitude, and outdoor installation) in severe weather, such as thunder, rain, snow, and gale level 6.</p>

	<p>In case of any fire, evacuate the building or equipment area and press the fire alarm bell or dial the fire call. Under any circumstances, re-entry into a burning building is strictly prohibited.</p>
	<p>Under no circumstances should the structure and installation sequence of the device be changed without the manufacturer's permission.</p>
	<p>The battery terminal components shall not be affected during transportation. And, the battery terminal bolts shall not be lifted or transported.</p>
	<p>It is strictly prohibited to alter, damage or block the marks and nameplates on the device.</p>
	<p>The composition and working principle of the entire photovoltaic power generation system, as well as the relevant standards of the country/region where the project is located shall be known fully.</p>
	<p>After the device is installed, the empty packing materials, such as cartons, foam, plastics, and cable ties, shall be removed from the device area.</p>

2.1.3 Personnel Safety

- When operating the device, appropriate personal protective equipment shall be worn. If any fault that may lead to personal injury or damage of the device is found, immediately terminate the operation, report to the responsible person, and take effective protective measures.
- Before using any tools, learn the correct method of using the tool to avoid injuries and damage of the device.
- When the device is running, the temperature of the case is high, which may cause burns. Therefore, do not touch the case.
- In order to ensure personal safety and normal use, reliable grounding should be carried out before use.
- Do not open or damage the battery. The electrolyte released is harmful to skin and eyes, so avoid touch it.
- Do not place irrelevant items on the top of the device or insert them into any part of the device.
- Do not place flammable items around the device.
- Never place the battery in the fire to avoid explosion and prevent the personal safety from being endangered.
- Do not place the battery module in water or other liquids.

- Do not short-circuit the battery terminals, because short-circuiting of the battery may cause combustion.
- The battery may pose a risk of causing electric shocks and large short-circuit currents. When using the battery, the following precautions should be paid attention to:
 - a) The metal objects, such as watch and rings, shall be removed.
 - b) Tools with insulated handles should be used.
 - c) Rubber gloves and shoes should be worn.
 - d) The charging power supply shall be disconnected before connecting or disconnecting terminals of the battery.
 - e) Check whether the battery is accidentally grounded. If the battery is accidentally grounded, remove the power supply from the ground.
- Do not clean the internal and external electrical components of the cabinet with water or detergent.
- Do not stand, lean or sit on the device.
- Do not damage any modules of the device.

2.2 Personnel Requirements

- The personnel in charge of installation and maintenance must be strictly trained to understand all safety precautions and master proper operation methods.
- Only qualified professionals or trained personnel are allowed to install, operate and maintain the device.
- The personnel who operate the device, including the operators, trained personnel and professionals, must have special operation qualifications required by the local country, such as high voltage operation, working high above the ground, and special equipment operation qualification.
- The replacement of device or components (including software) must be carried out by professionals or authorized personnel.

2.3 Electrical Safety

2.3.1 General Requirements



Before carrying out electrical connections, ensure that the device is not damaged, or an electric shock or fire may occur.



Never install or remove any power cables when the power is on. The electric arcs or sparks may be generated at the moment when the power cable contacts with the conductor, which may cause fire or personal injuries.

- All the electrical connections must meet the electrical standards of the country/region where the project is located.
- The cables prepared by users themselves shall comply with local laws and regulations.
- Special insulating tools should be used in high-voltage operations.
- Before connecting the power cord, ensure that the label identification on the power cord is correct.
- Operations on the device are allowed only five minutes after the device is completely powered off.
- The insulation layer of the cable may be aged or damaged when the cable is used in a high temperature environment. Therefore, the distance between the cable and the heat source must be at least 30mm.
- Cables of the same type should be bundled together. Whereas, the cables of different types should be routed at least 30mm apart, and shall not be wrapped together or crossed.

2.3.2 Grounding Requirements

- When installing the device to be grounded, the protective grounding wire must be installed first; when removing the device, the protective grounding wire must be removed at last.
- It is forbidden to destroy the grounding conductor.
- It is forbidden to operate the device without a grounding conductor installed.
- The device shall be permanently connected to the protective grounding wire. Before operating the device, electrical connection of the device shall be checked to ensure that the device is reliably grounded.

2.4 Installation Environment Requirements

- This product is for indoor use only, and is strictly prohibited to be used in outdoor environment.
- Do not install or use this product in an environment where the temperature is lower than -10 °C or higher than 50 °C.
- It should be installed in a dry and well-ventilated environment to ensure good heat dissipation performance.
- The product can be installed at a maximum altitude of 2,000m.
- The installation position should be away from the fire source.
- The product should be installed and used away from children and animals.
- The installation position should be far away from water sources, such as faucets, sewer pipes, and sprinklers, to avoid entering of water.
- The device should be placed on a firm and flat supporting surface.
- Do not place any inflammable or explosive items around the device.
- When the device is running, do not block the ventilation vent or heat dissipation system to prevent fire caused by high temperature.

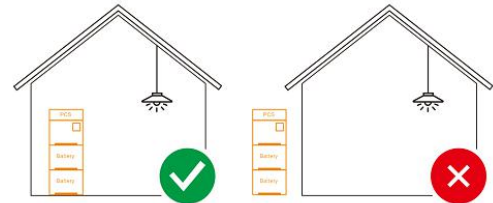

The operation and service life of the energy storage is related to the operating temperature. The energy storage should be installed at a temperature equal to or better than the ambient temperature.

**Max+50°C****Min-10°C****RH.+5%~+95%**

3 Product Introduction

3.1 Brief Introduction to Product

SR-EOV is a new generation of household energy storage system with two output specifications of 220V and 110V, which can meet the diversified needs of global users. The SR-EOV energy storage system adopts a modular design, including power modules and battery expansion modules, so it can be easily combined into a system of any capacity required by the user.

The lithium iron phosphate batteries with high performance and long service life are used in the energy storage module. Meanwhile, the modular structure design is adopted. Each energy storage module is internally integrated with the intelligent BMS system, which can be easily expanded and can be combined into 20Kwh battery pack at most.

The brand new topological circuit design is adopted in the power module, which can realize the energy exchange between photovoltaic, mains, battery and loads, and has the function of photovoltaic and mains charging. The photovoltaic charging module adopts the latest optimized MPPT tracking technology, which can quickly track the maximum power point of the photovoltaic array in any environment, and obtain the maximum energy of the solar panel in real time. In addition, MPPT has a wide voltage range. The advanced control algorithm is adopted in the mains charging module to realize the fully-digital double closed-loop control of voltage and current, so the control precision is high and the volume is small. The AC voltage input range is wide, and the input/output protection functions are complete, which can realize the stable and reliable charging and protection of batteries. The inverter module is based on the full-digital intelligent design, adopts the advanced SPWM technology, outputs pure sine wave, converts direct current into alternating current, and is applicable for household appliances, power tools and other AC loads.

The typical topological diagram for application of the system is as follows:

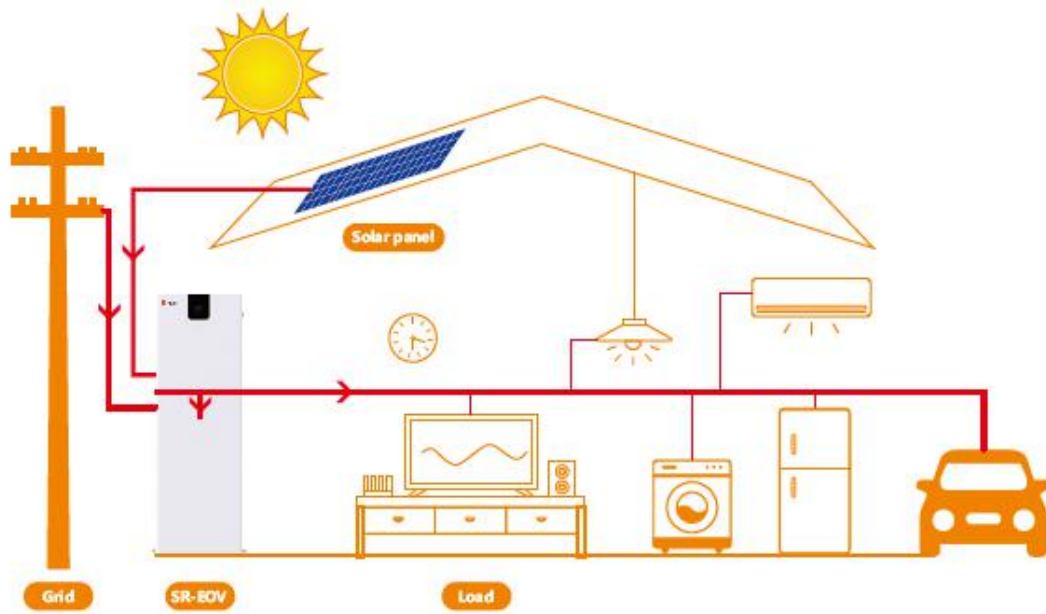

3.2 System Specifications

Product model	Battery Energy	Rated Output Power	Rated Output Voltage (Vac)	Frequency	Charge Current	Max. PV Power
SR-EOV24-5.0S-S1	5.12kWh	3500W	230Vac	50Hz	0 ~ 80A	4000W
SR-EOV24-5.0U-S1	5.12kWh	3500W	120Vac	60Hz	0 ~ 80A	4000W
SR-EOV24-10.0S-S1	10.24kWh	3500W	230Vac	50Hz	0 ~ 80A	4000W
SR-EOV24-10.0U-S1	10.24kWh	3500W	120Vac	60Hz	0 ~ 80A	4000W
SR-EOV24-15.0S-S1	15.36kWh	3500W	230Vac	50Hz	0 ~ 80A	4000W
SR-EOV24-15.0U-S1	15.36kWh	3500W	120Vac	60Hz	0 ~ 80A	4000W
SR-EOV24-20.0S-S1	20.48kWh	3500W	230Vac	50Hz	0 ~ 80A	4000W
SR-EOV24-20.0U-S1	20.48kWh	3500W	120Vac	60Hz	0 ~ 80A	4000W

3.3 Model Coding

The model coding of the energy storage battery is as follows:

SR-EOV24-5.0S-S 1

①
②
③
④
⑤
⑥

Identifier	Meaning	Value
①	Product type	EOH: horizontally-mounted EOV: vertically-mounted EOS: wall-mounted
②	System voltage	24: 24V system 48: 48V system
③	Energy storage capacity level	5.0: The system capacity is 5kWh 10.0: The system capacity is 10kWh
④	Output voltage	U: The output voltage is 110V S: The output voltage is 220V
⑤	Product category	S: Energy storage system E: Energy storage battery module C: Power conversion module
⑥	Version number	1: Version 1

SR-EOV24-3.5S-C 1

①
②
③
④
⑤
⑥

Identifier	Meaning	Value
①	Product type	EOH: horizontally-mounted EOV: vertically-mounted EOS: wall-mounted
②	System voltage	24: 24V system 48: 48V system
③	Output power level	3.5: The system capacity is 3.5kW 5.0: The system capacity is 5.0kW
④	Output voltage	U: The output voltage is 110V S: The output voltage is 220V
⑤	Product category	C: Power module
⑥	Version number	1: Version 1

SR-EOV24-5.0A-E 1

Identifier	Meaning	Value
①	Product type	EOH: horizontally-mounted EOV: vertically-mounted EOS: wall-mounted
②	System voltage	24: 24V system 48: 48V system
③	Energy storage capacity level	5.0: The system capacity is 5kWh 10.0: The system capacity is 10kWh
④	Energy storage battery type	A: Lithium iron phosphate (LiFePO4)
⑤	Product category	E: Energy storage battery
⑥	Version number	1: Version 1

3.4 Description of Energy Storage Capacity

SR-EOV series energy storage system supports the capacity expansion with up to four energy storage modules.

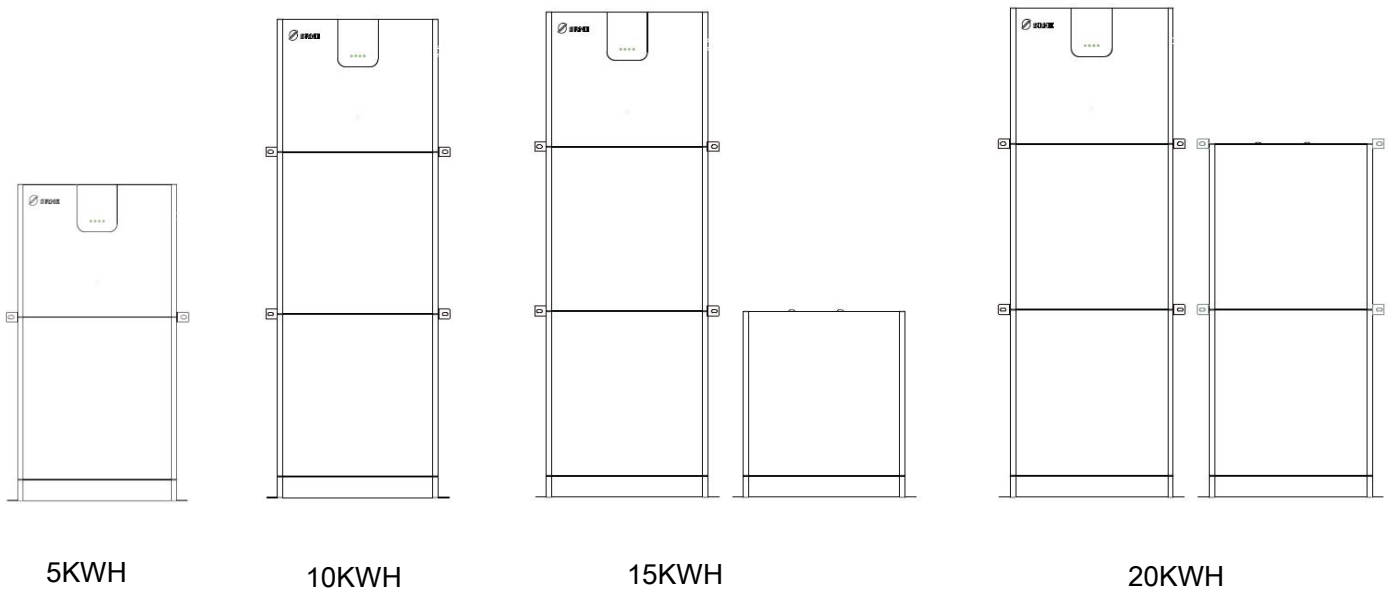

3.5 Appearance Description

3.5.1 Dimensions

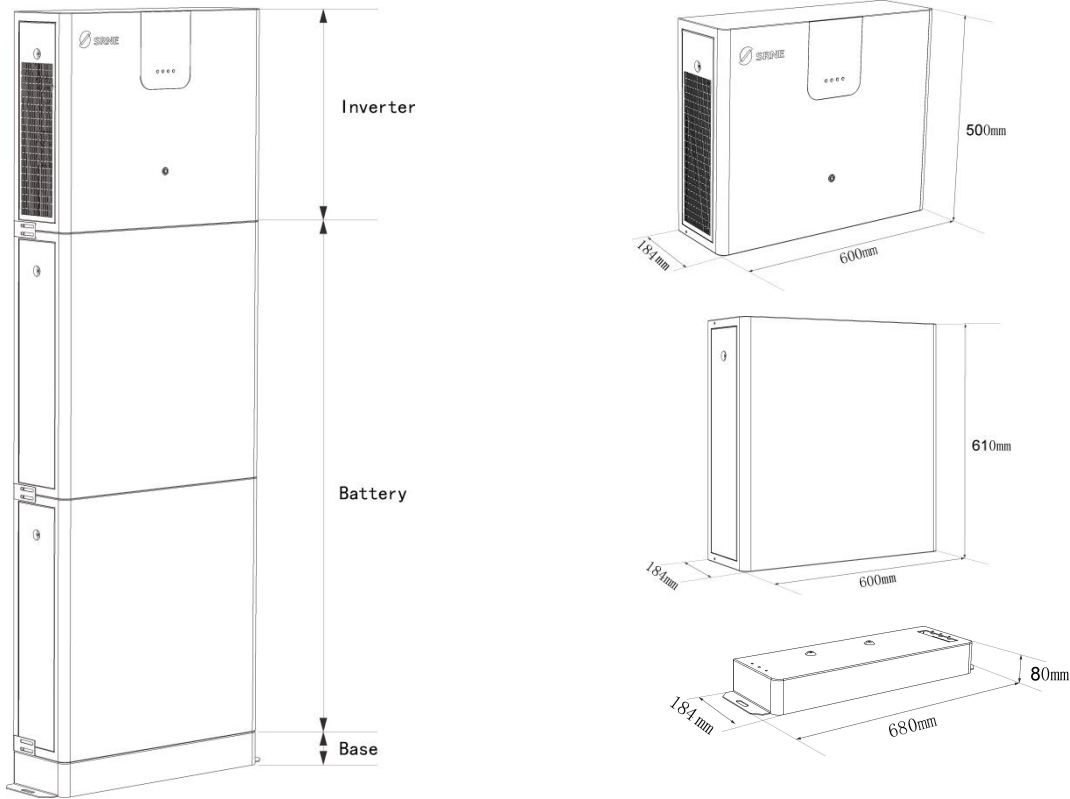

Inverter dimensions (L*W*H) :600*184*500mm

Battery dimensions (L*W*H) :600*184*610mm

Base dimensions (L*W*H) :680*184*80mm

3.5.2 Power Conversion System Module

The power of power conversion system is 3.5KW.

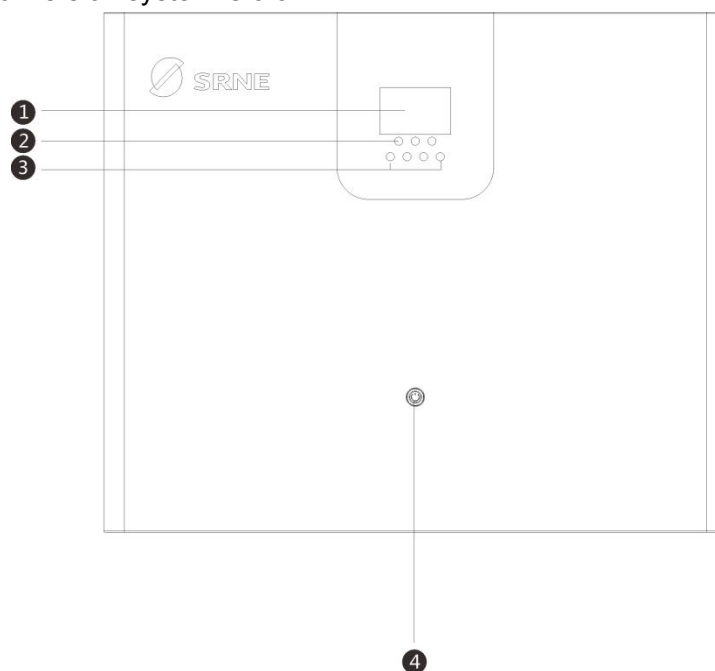

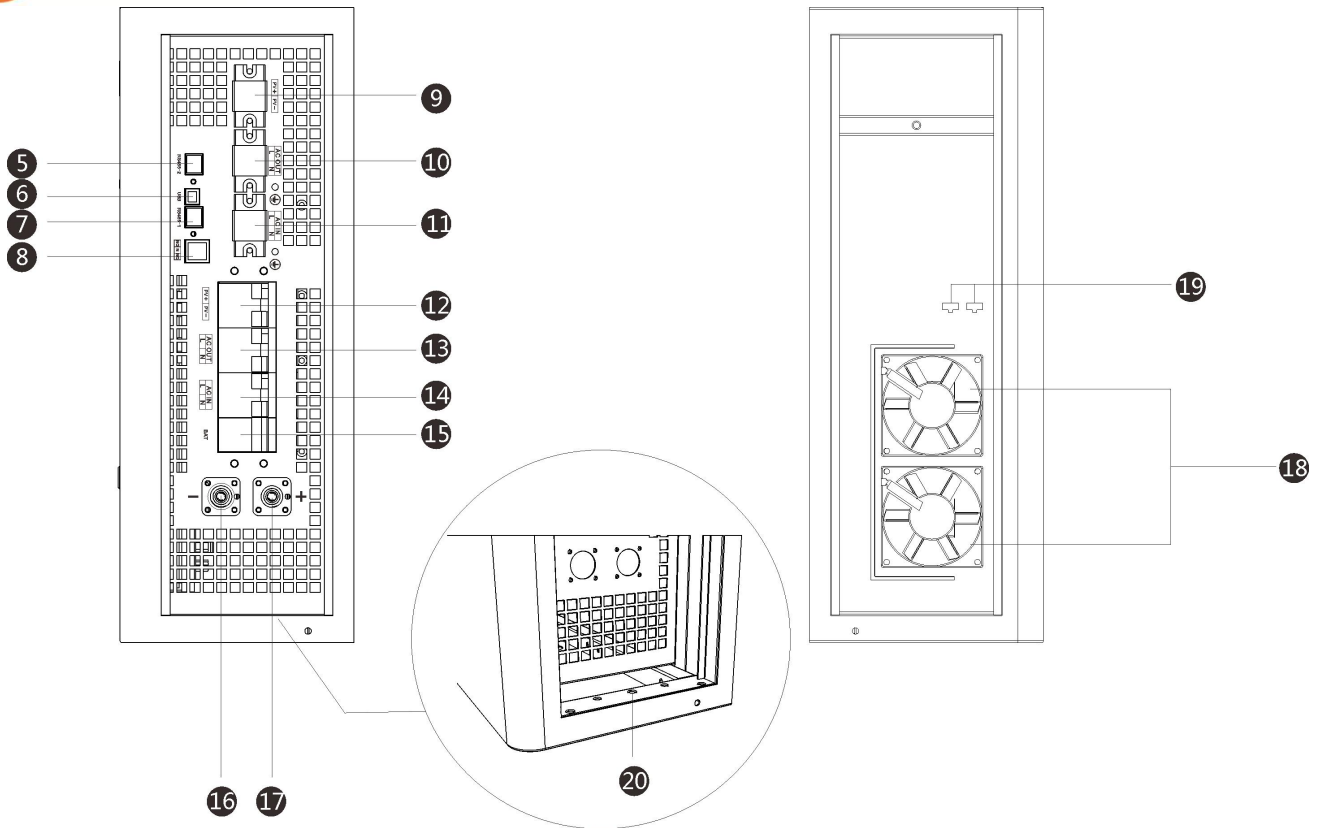

① LCD	② LED indicator	③ Operation keys	④ Inverter ON/OFF
⑤ RS485-2 (Connect battery)	⑥ USB	⑦ RS485-1	⑧ Dry contact (Start generator)
⑨ PV input port	⑩ AC output port	⑪ AC input port	⑫ PV input switch
⑬ AC output switch	⑭ AC input switch	⑮ Battery switch	⑯ Battery Negative
⑰ Battery Positive	⑱ Cooling fan	⑲ Fan connector	⑳ Grounding screw

Communication interface definition

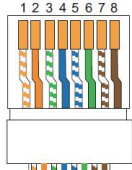
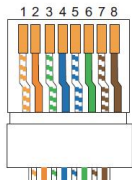
Number	Communication	Function	Interface Type	Picture	instruction
⑤	RS485-2	Connect battery	RJ45		7-RS485-A 8-RS485-B
⑦	RS485-1	Connect PC/WiFi	RJ45		1-5V 2-GND 7-RS485-A 8-RS485-B

3.5.3 Energy Storage Battery Module

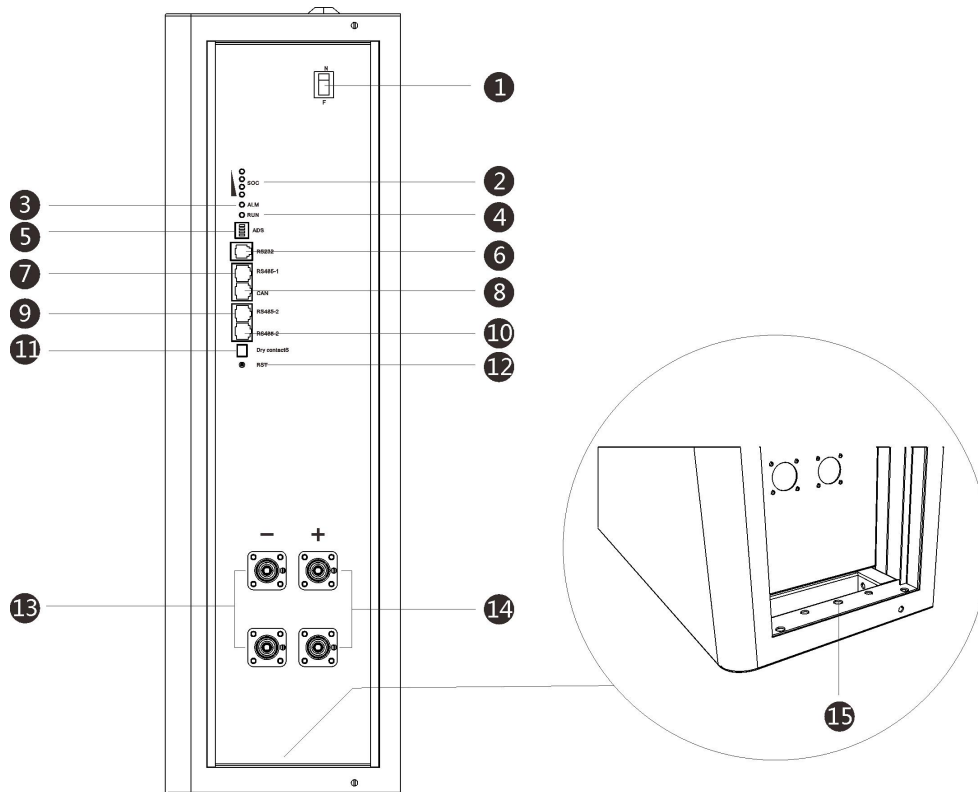

① Turn On/Off	② LED(SOC)	③ LED(ALM)	④ LED(RUM)
⑤ Address	⑥ RS232	⑦ RS485-1 (Connect inverter)	⑧ CAN (Connect inverter)
⑨ RS485-2 (Connect other battery)	⑩ RS485-2 (Connect other battery)	⑪ Dry contact	⑫ Reset
⑬ Battery Negative	⑭ Battery Positive	⑮ Grounding screw	

Communication interface definition

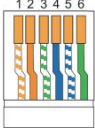
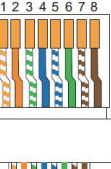
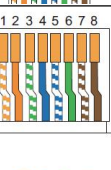
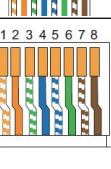
Number	Communication	Function	Interface Type	Picture	instruction
⑥	RS232	Connect PC	RJ12		3-TX 4-RX 5-GND
⑦	RS485-1	Connect inverter	RJ45		1-RS485-B 2-RS485-A
⑧	CAN	Connect inverter	RJ45		4-CAN-H 5-CAN-L
⑨⑩	RS485-2	Connect other battery	RJ45		1-RS485-B 2-RS485-A 7-RS485-A 8-RS485-B

4 Application Scenarios

The lithium iron phosphate batteries with high performance and long service life are used in the energy storage module. Meanwhile, the modular structure design is adopted. Each energy storage module is internally integrated with the intelligent BMS system, which can be easily expanded and can be combined into 20Kwh battery pack at most.

The battery storage can be combined with SRNE brand inverter to form an off-grid photovoltaic system, which can solve the problem of electricity consumption in areas without electricity.

4.1 Application Scenarios

4.1.1 Application Scenarios with Only Mains Power but No Photovoltaic

When the mains is normal, it charges the battery and supplies power to the loads.

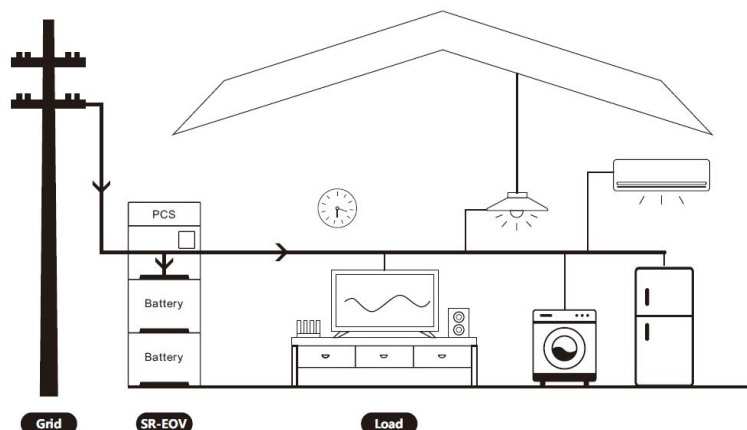

When the mains is disconnected or stops working, the battery supplies power to the load through the power module.

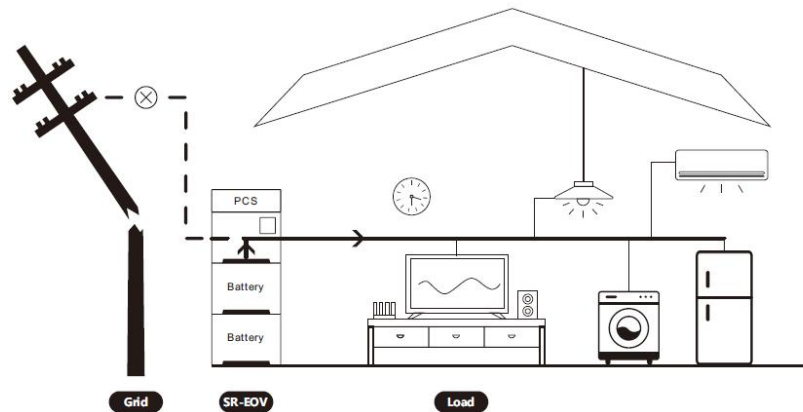

4.1.2 Application Scenarios with Only Photovoltaic but No Mains Power

During the day, the photovoltaic directly supplies power to the loads while charging the battery.

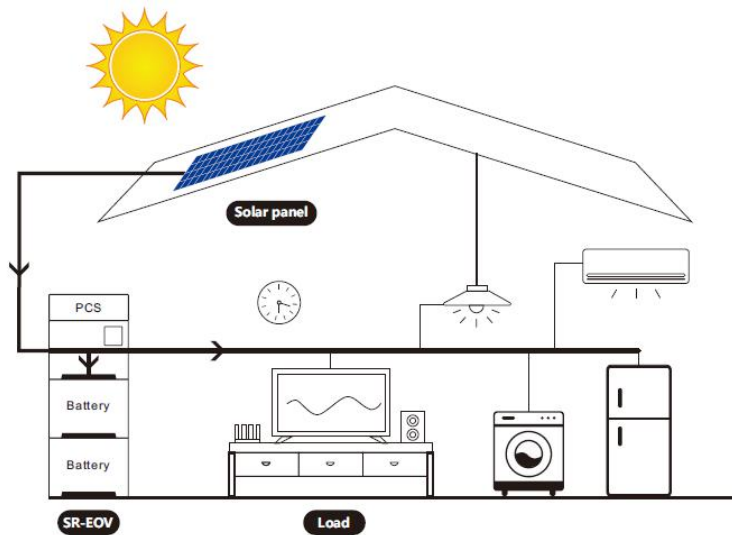

At night, the battery supplies power to the loads through the power module.

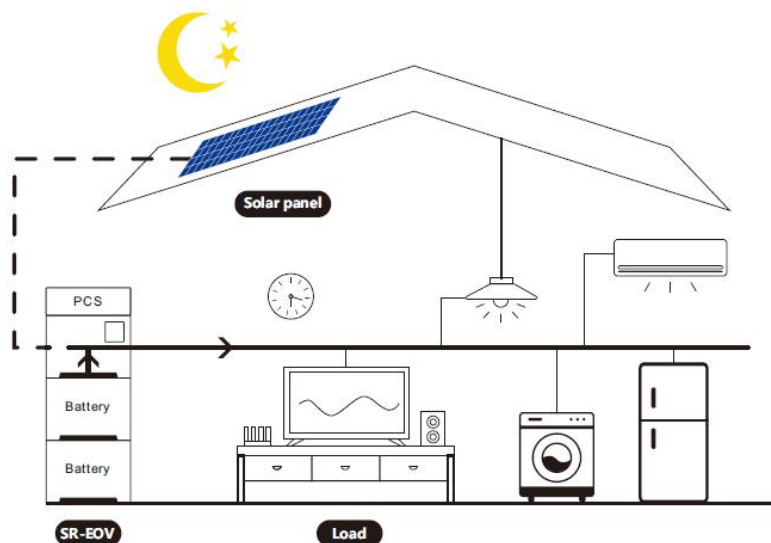

4.1.3 Complete Application Scenarios

During the day, the mains and photovoltaic simultaneously charge the battery and supply power to the loads.

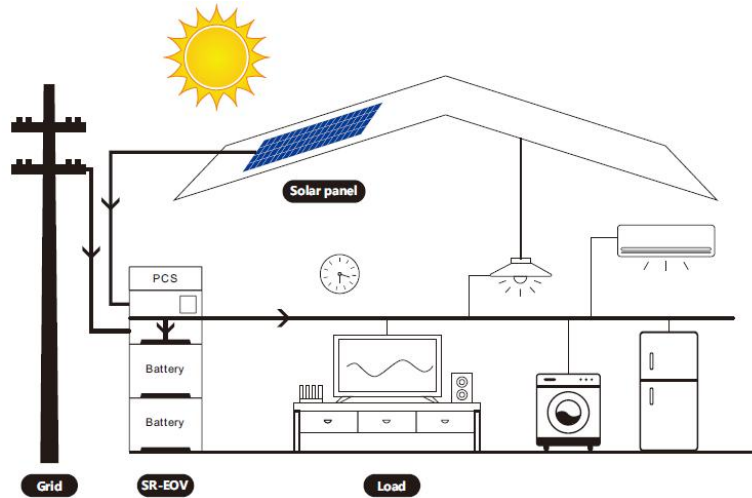

At night, the mains supplies power to the loads, and continues to charge the battery, if the battery is not fully charged.

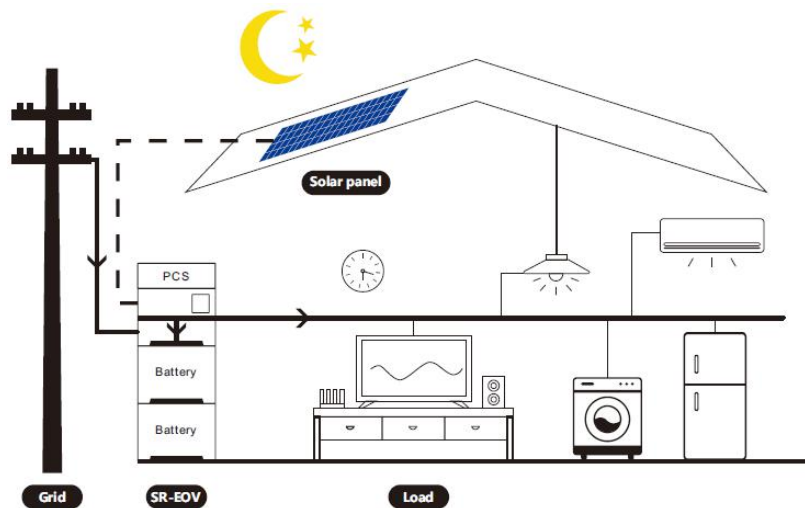

If the mains is disconnected, the battery supplies power to the loads.

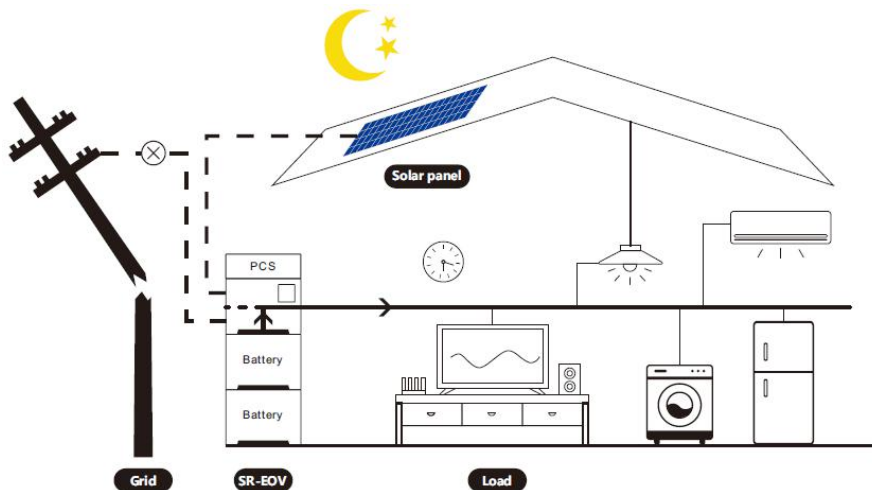

4.2 Load Working Mode

Load working mode	Inverter setting	Description
PV priority mode	SOL	switching to the Mains when the PV fails or the battery is lower than the set value of parameter
Mains priority mode	UTI	Mains priority mode, switching to inverter only when the mains fails.
Inverter priority mode	SBU	switching to the mains only when the battery is under voltage or lower than the set value of parameter

5 System Installation





5.1 Inspections before Installation

Inspection of outer package



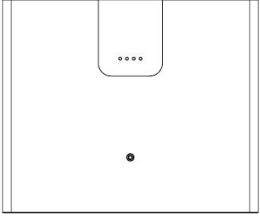
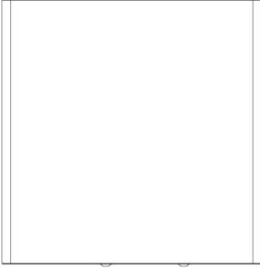

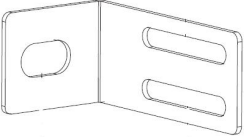
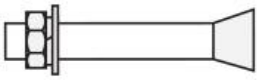

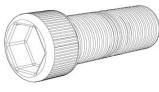
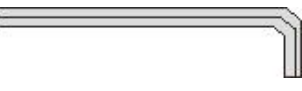

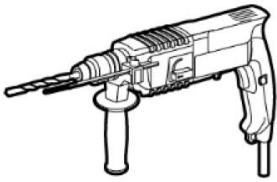

Before opening outer package of the energy storage, check if there is any visible damage on the outer package, such as holes, cracks or other signs of possible internal damage, and check the type of energy storage. If there is any abnormality on the package or model of the energy storage is inconsistent, do not open it and contact us as soon as possible.

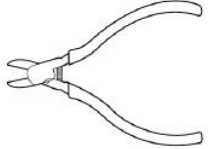
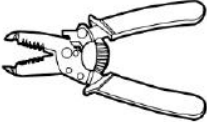
Inspection of deliverables

After opening outer package of the energy storage, check if the deliverable is complete and whether there is any visible external damage. If any items are missing or damaged, please contact us.

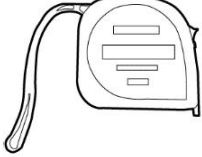
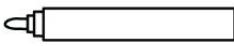
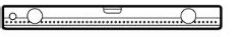
NO.	Picture	Item	Quantity	Specification	Source
1		Inverter	1	3.5kW/24V,110V/220V	Inverter Package
2		Battery	N	5.12kWh/25.6V	Battery Package
3		Base	1	680*184*80mm	Inverter Package
4		Mounting Frame	2*N	80*44mm	Battery Package
5		Mounting Frame Screw	2*(N+1)	M8*60 expansion bolt	Battery Package
6		Screw	8*N	M5*10	Battery Package
7		Fixing screw	2*N	M6*35	Battery Package
8		Hexagon wrench	N	120*30mm	Battery Package
N: Number of batteries					

5.2 Preparation of Tools and Meters

Types	Tools and meters		
Installation tool			
			  
			
Personal protective equipment			
			

5.3 Selection of Installation Location

5.3.1 Basic Requirements

- When the energy storage is running, the temperature of the case and the radiator will be high. Therefore, do not install them in a place that is easy to touch.
- Do not install in areas where flammable and explosive materials are stored.
- If the energy storage is installed in areas with salt damage, it will be corroded and may cause fire. Therefore, do not install it outdoors in areas with salt damage. The areas with salt damage are defined as the areas which are not 500m away from shore or will be affected by sea breezes. The areas affected by the sea breezes vary depending on meteorological conditions (e.g. typhoons, monsoons) or topographical conditions (dams, hills).
- Do not install in the place where children can touch.

- The energy storage cannot be installed forwardly, horizontally, inversely, backwardly or sideways.
- When drilling holes on walls or ground, the goggles and protective gloves shall be worn.
- During drilling, the device should be shielded to prevent debris from falling into the device. After drilling, the debris shall be cleaned up in time.
- When handling any heavy objects, you should be prepared to bear loads to avoid being crushed or sprained.
- When handling the device by hand, wear protective gloves to avoid injury.

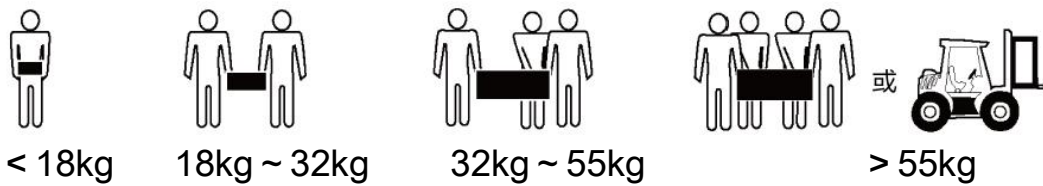

5.3.2 Installation Space Requirements

When installing the energy storage, certain space shall be left around it to ensure sufficient space for installation and heat dissipation.

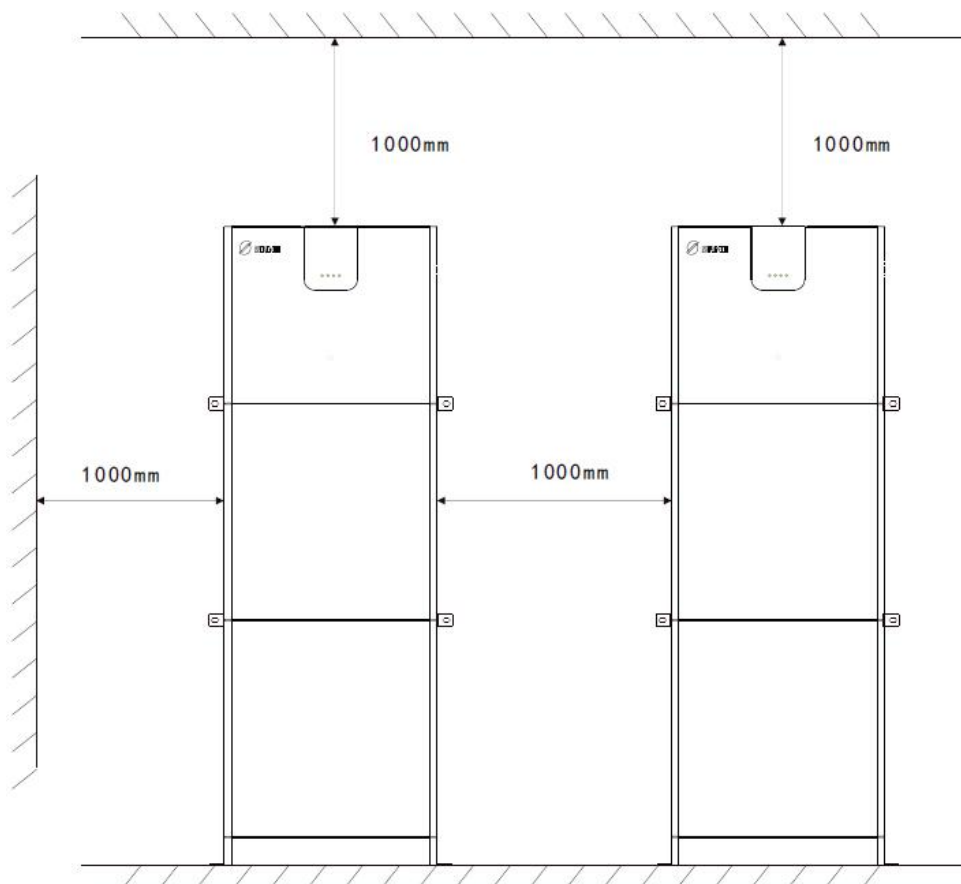

5.4 Device Installation

5.4.1 Installation Location Selection

Determine the installation location, please choose a flat ground and a solid wall as the installation location.
First, determine the installation position of the base, the fixed size is 648mm.

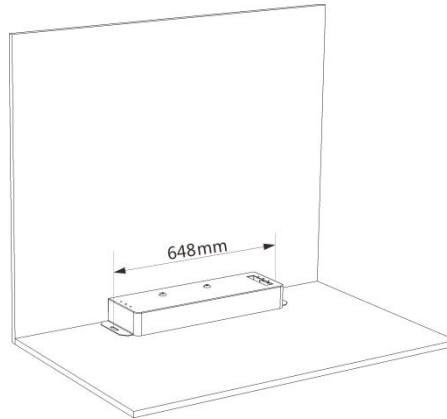

Second, determine the installation position of the battery and inverter.

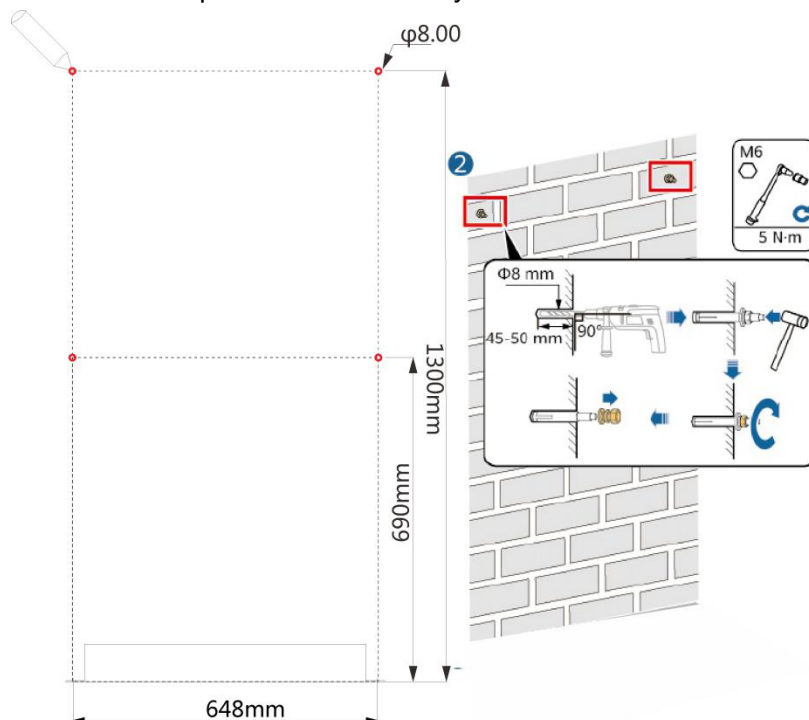

5.4.2 Install Expansion Bolts



In order to avoid electrical shock or other injury, inspect existing electronic or plumbing installations before drilling holes.



Choose suitable firm wall with thickness greater than 80mm.

According to the hole position, drill 2 holes on the ground and 4 holes on the wall, $\phi 8$, depth 45~50mm. Tap the M8 screw into the above hole and screw on the nut.

5.4.3 Mounting the base

Fasten the base to the expansion screw.

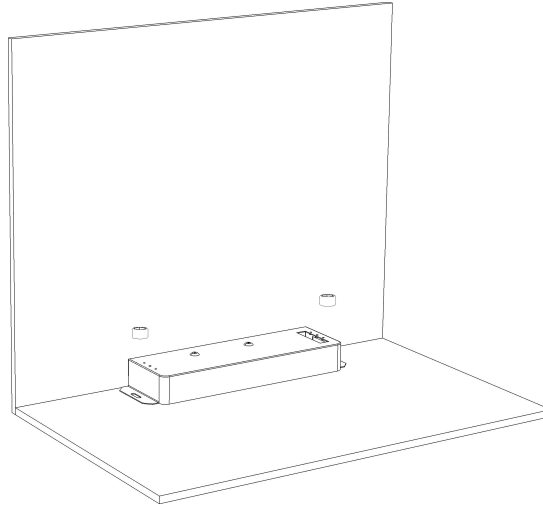

5.4.4 Install Battery Pack



The battery pack is very heavy, which requires multiple people to install.

Place the battery on the base, and then tighten the fixing screws on both sides.

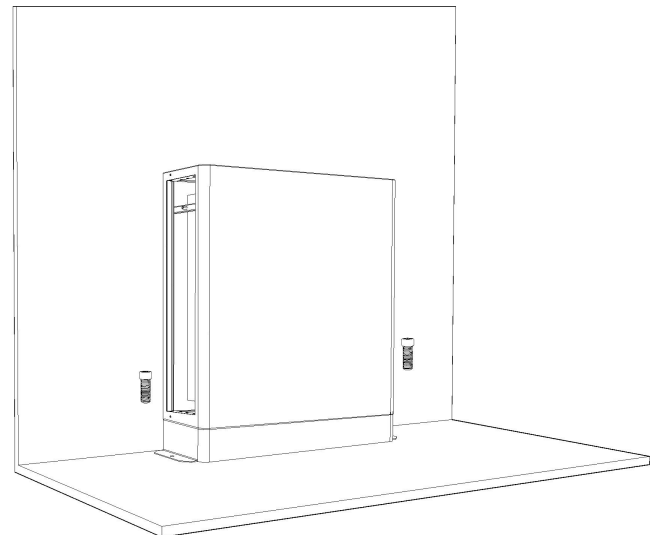
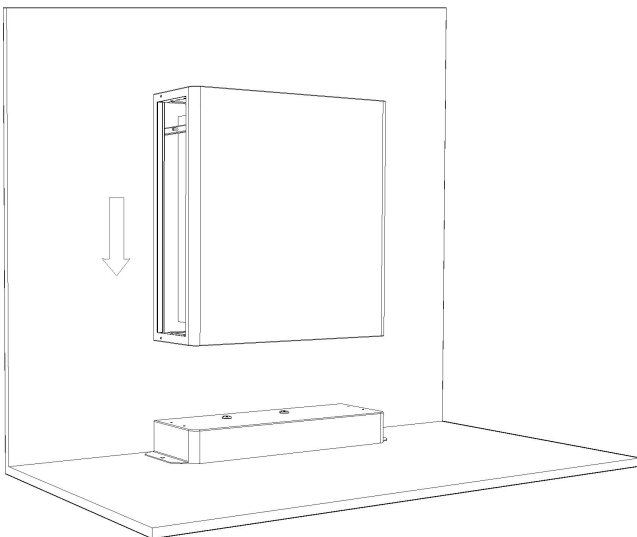

Install the second battery in the same way. After the installation is complete, install the wall fixing bracket.

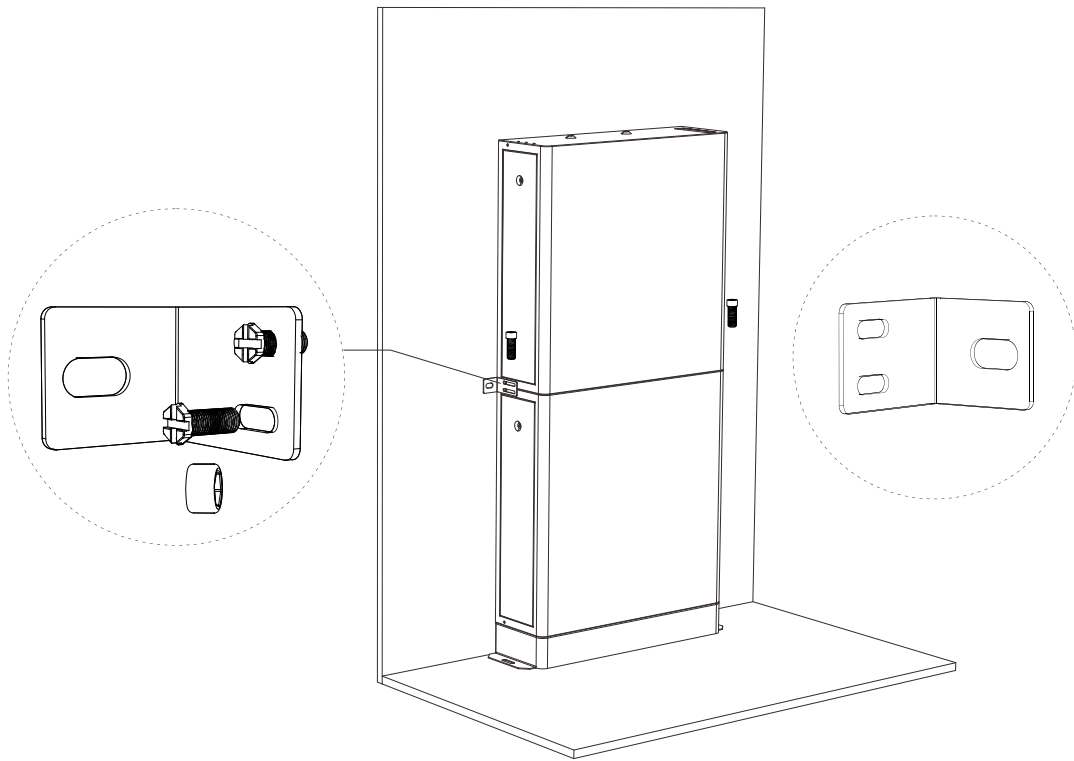

5.4.5 Install Inverter

The installation method of the inverter is the same as that of the battery.

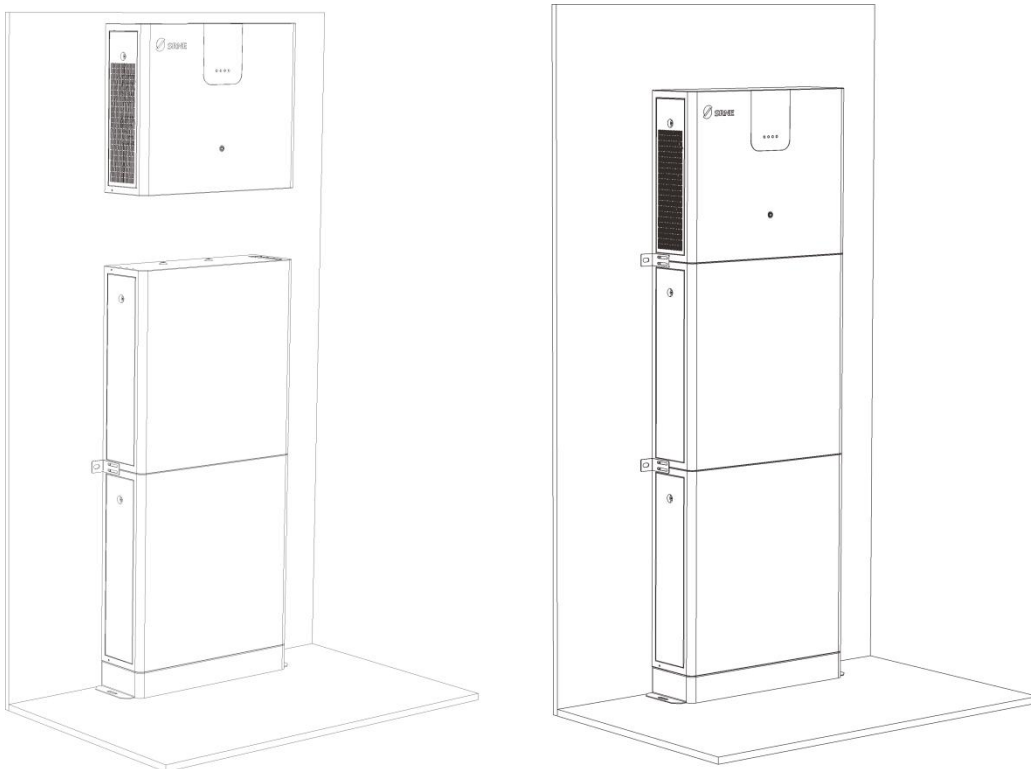

6 Electrical Connection



Before electrical connection, please ensure that the switches of the energy storage are in the "OFF" state. Otherwise, the high voltage of the device may cause electric shock.



The operations related to electrical connections must be carried out by professional electrical technicians. When carrying out electrical connections, the operator must wear personal protective articles.

6.1 Preparation of Cables

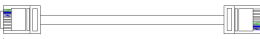
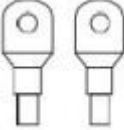
No.	Cables	Description	Recommended specifications	Source
1	Power Cable	Power cable between the storage battery and inverter		Battery Package
2	Signal line	Signal cable between battery modules or between battery and inverter		Battery Package
3	Wiring ring	Connect wires and terminals		Inverter Package
5	Photovoltaic input line	Cable between the photovoltaic panel and power module	Cable diameter 6mm ² /10AWG	Prepare by the user itself
6	AC input line	Cable between AC input and power module	Cable diameter 10mm ² /7AWG	Prepare by the user itself
7	AC output line	Cable between AC output and power module	Cable diameter 10mm ² /7AWG	Prepare by the user itself

6.2 Internal Electrical Connection of Energy Storage

6.2.1 Connecting Power Cord

Before connecting the energy storage battery module, ensure that the energy storage battery is not working and the indicator lights on the battery are OFF. The power cord delivered with the product together should be used to connect the positive and negative terminals of other batteries or power modules. It shall be noticed that the red cable should be connected to the red terminal (positive battery terminal) and the black cable to the black terminal (negative battery terminal).

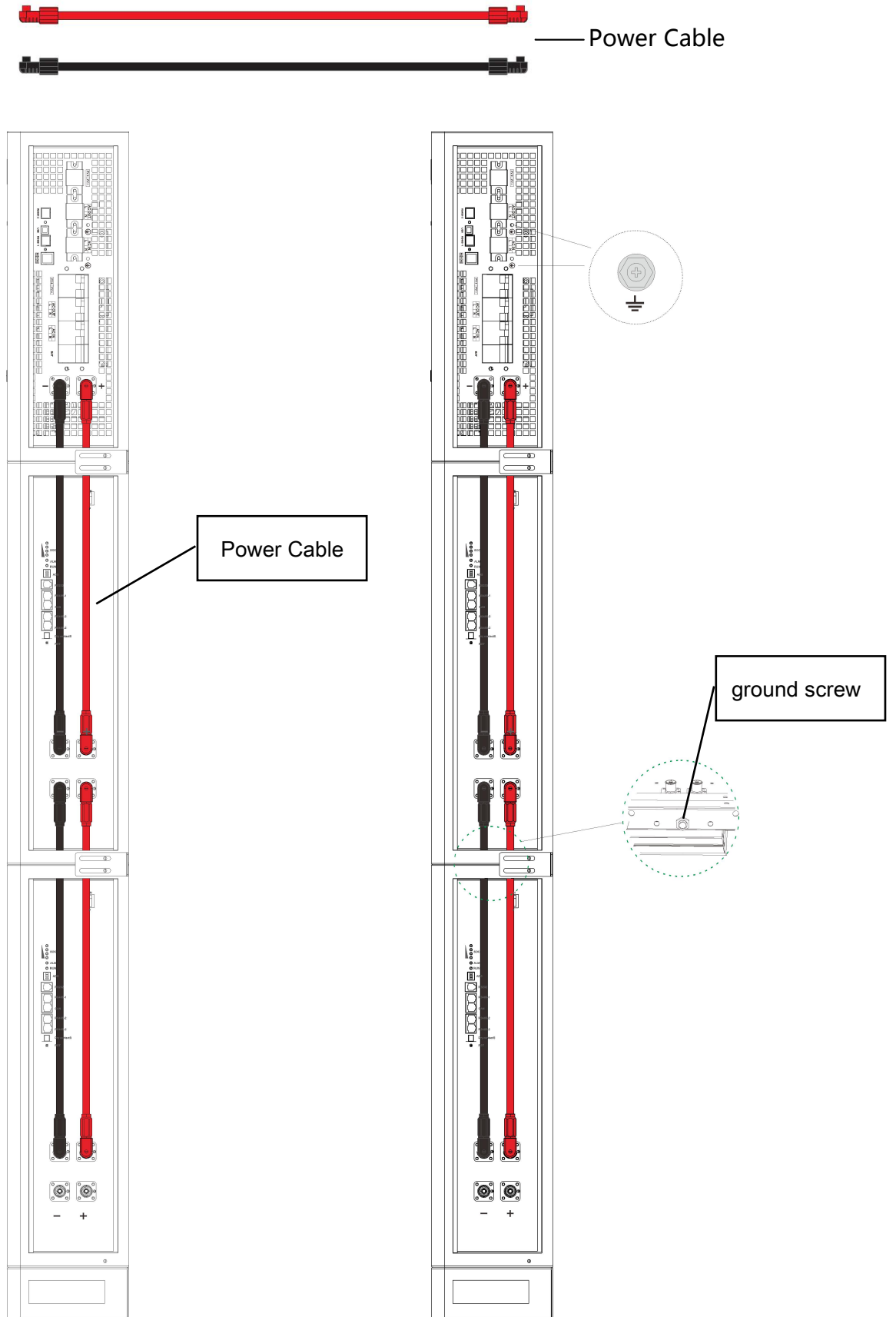

6.2.3 Connecting Signal Line

The signal line delivered with the product together shall be used to connect RS485-2 interface for each battery module.

The inverter communication interface connects the 485-2 and the 485-1 interface of the battery.

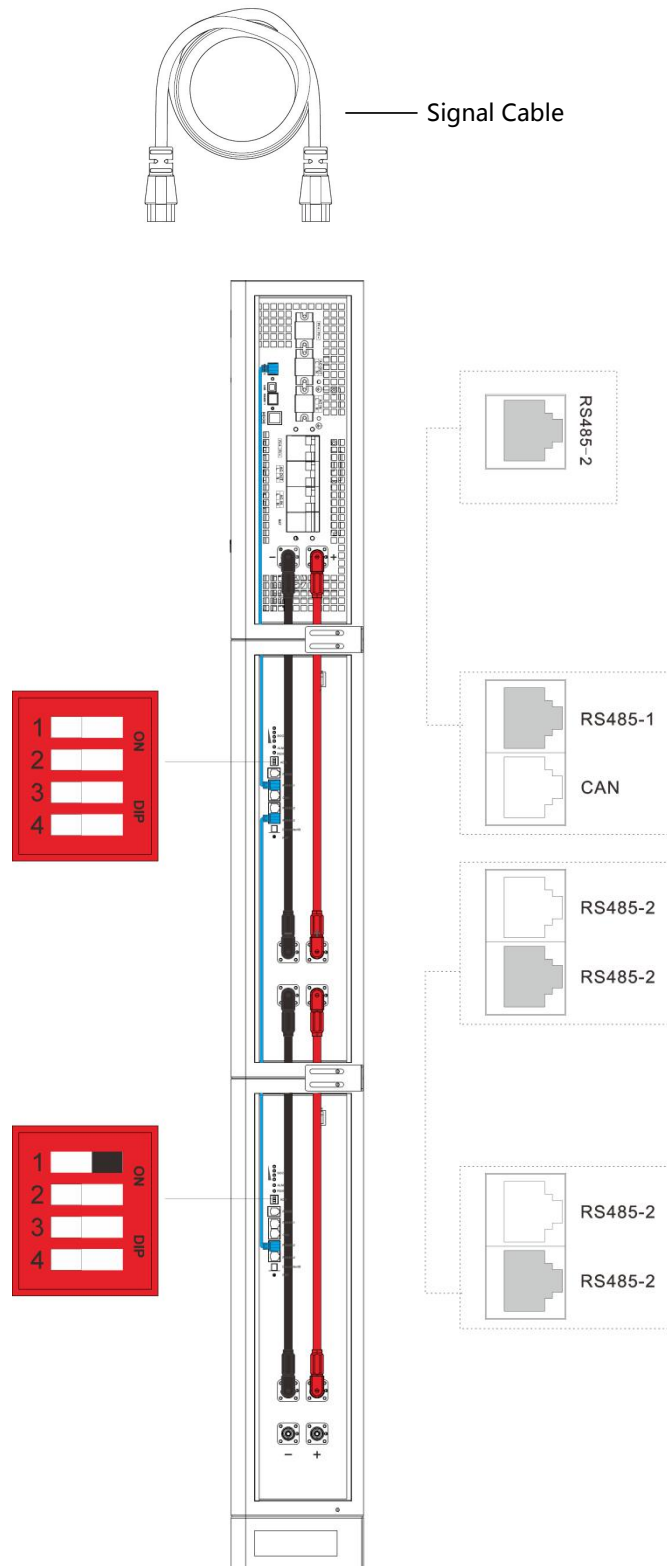

6.2.4 Energy Storage Battery Module Address Setting

If multiple energy storage battery modules are used in parallel, the address of the energy storage battery module needs to be set. The address is set to 0~3, and the address of each module cannot be repeated.

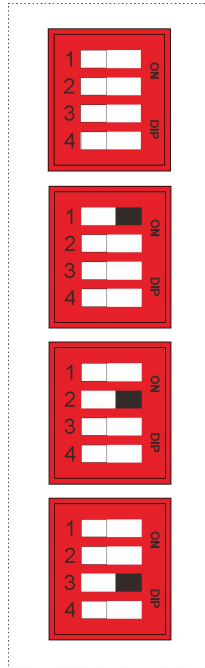

The address of the battery connected to the inverter must be set as 0.

6.3 External Electrical Connection of Energy Storage

6.3.1 Connecting AC Input

According to the cable sequence and terminal position shown in the figure below, correctly connect the AC input line. Please pay attention to L and N and avoid short-circuit when wiring.

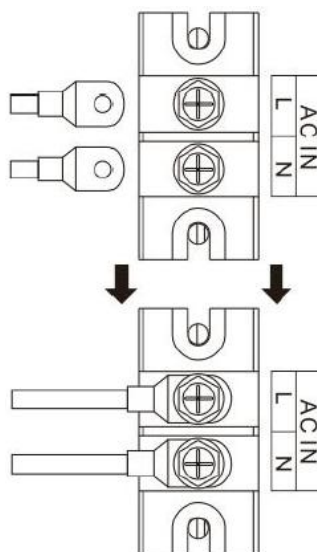

6.3.2 Connecting AC Output

According to the cable sequence and terminal position shown in the figure below, correctly connect the AC output cable. When wiring, please pay attention to L and N and avoid short-circuit.

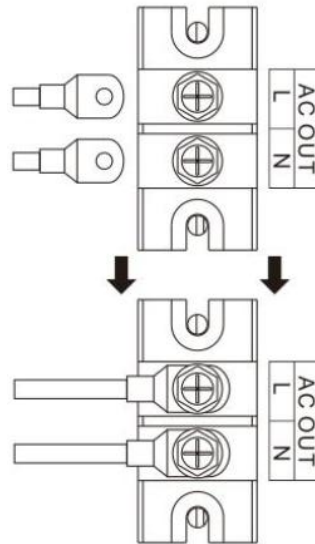

6.3.3 Connecting Photovoltaic Input

According to the cable sequence and terminal position shown in the figure below, correctly connect the PV input cable. When wiring, please pay attention to the positive and negative poles and avoid short-circuit.

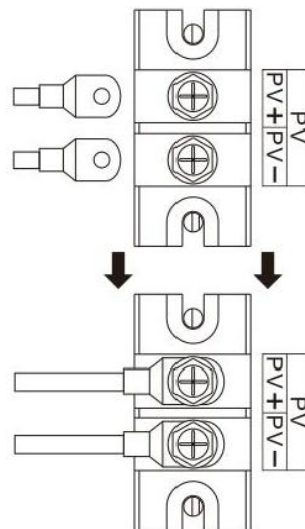

6.3.4 Wiring specifications

Models	Recommended PV wiring diameter	Recommended AC input wiring diameter	Recommended AC output wiring diameter
SR-EOV24-3.5S-C0	12mm ² /10AWG	6mm ² /10AWG	6mm ² /10AWG
SR-EOV24-3.5U-C0	12mm ² /10AWG	6mm ² /10AWG	6mm ² /10AWG

7 System Debugging

7.1 Inspections Before Power-On

No.	Inspection items	Acceptance criteria	Validation
1	The energy storage is installed in place	The installation is correct, secure and reliable.	<input type="checkbox"/> Yes <input type="checkbox"/> No
2	The installation environment meets requirements	The installation space is reasonable and the environment is clean and tidy without any construction	<input type="checkbox"/> Yes <input type="checkbox"/> No
3	The power cord is correctly connected	The positive and negative terminals are connected correctly without any missing.	<input type="checkbox"/> Yes <input type="checkbox"/> No
4	The signal line is correctly connected	The signal line is connected reliably, and there is no wrong position	<input type="checkbox"/> Yes <input type="checkbox"/> No
5	The grounding is reliable	The grounding wire is correctly and reliably connected.	<input type="checkbox"/> Yes <input type="checkbox"/> No
6	The switch of the energy storage battery module is off	All switches connected to the energy storage are in the "OFF" state.	<input type="checkbox"/> Yes <input type="checkbox"/> No
7	All breaker of the battery module are off	All breaker of the battery module are in the "OFF" state.	<input type="checkbox"/> Yes <input type="checkbox"/> No

7.2 Power-On of Power Module

7.2.1 Inverter Breaker Sequence

First, Turn on the battery input breaker switch; then turn on the PV, AC output and AC input breaker switch.

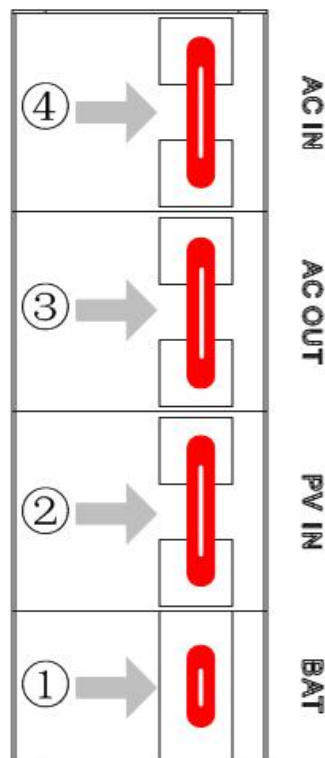

7.2.2 Power-On of Energy Storage Battery Module

After turn on the battery input breaker switch and confirmation, turn on the switch of the energy storage battery module. If there are multiple modules, please turn on the power switch one by one according to the address sequence.

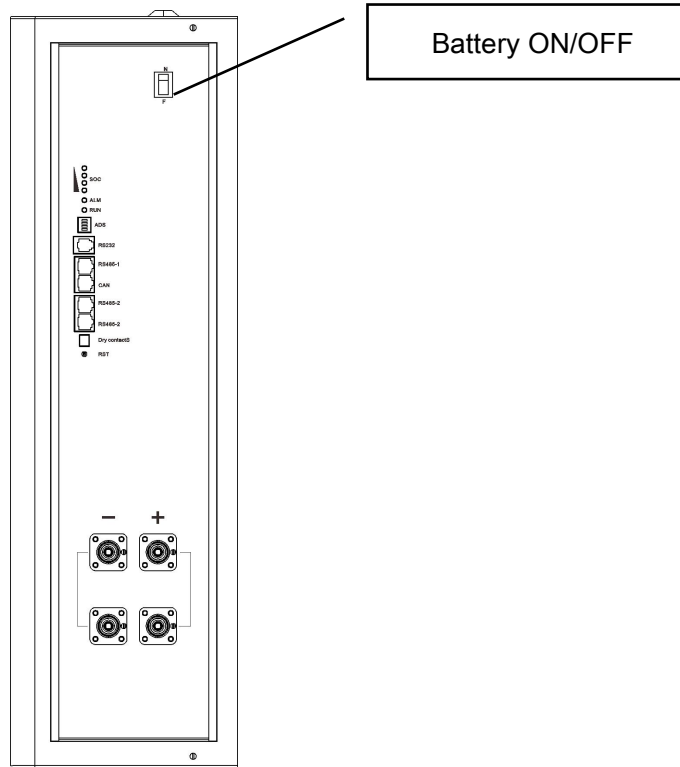

After the power switch is turned on, the LED indicator will light up or flash. The meaning of the LED indicator is as follows.

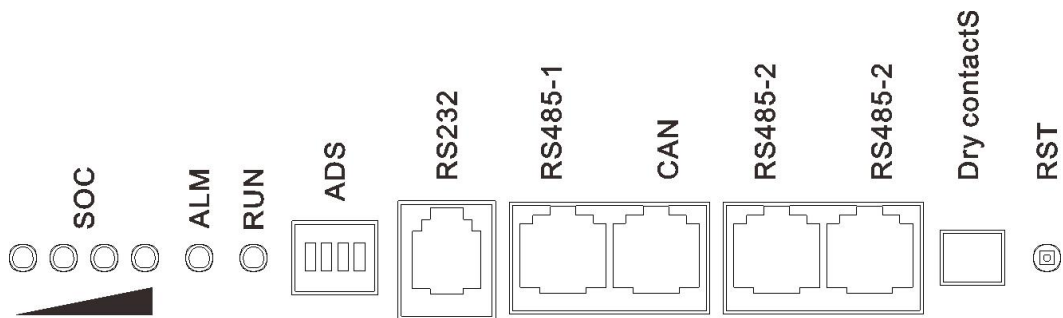







System Status	Events	RUN	ALM
POWER OFF	Power Off	OFF	OFF
Steady	Normal	Blinking1	OFF
	Alarm	Blinking1	Blinking3
Charging	Normal	ON	OFF
	Alarm	ON	Blinking3
	Over Charge Protection	ON	OFF

	High temperature, Over Current	OFF	ON
Discharging	Normal	Blinking3	OFF
	Alarm	Blinking3	Blinking3
	Over Discharge Protection	OFF	OFF
	Over Current , Short Current	OFF	ON

LED blinking description

Blinking	LED ON	LED OFF
Blinking1	0.25S	3.75S
Blinking2	0.5S	0.5S
Blinking3	0.5S	1.5S

7.2.3 Capacity Indicator

Capacity indicator LED	SOC
	0 ~ 25%
	25 ~ 50%
	50 ~ 75%
	75 ~ 100%
 : LED ON  : LED OFF	

7.2.4 Power-On of Inverter

After all loads are connected, press the button switch on the front of the machine, The "AC/INV" indicator flashing indicates that the inverter is working normally.

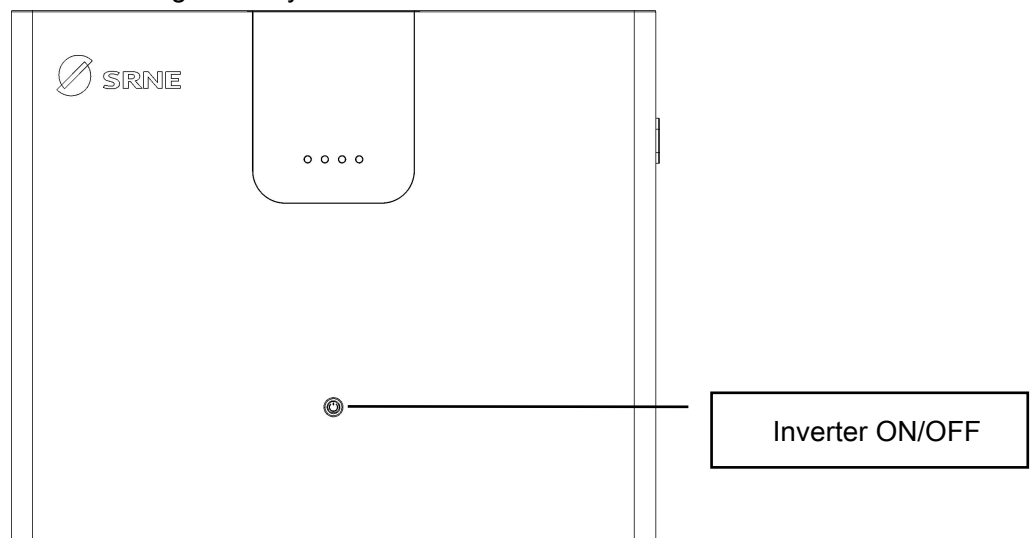

7.2.5 Inverter LED And Button Function Description

After the power module works normally, the indicator lights are described as follows:

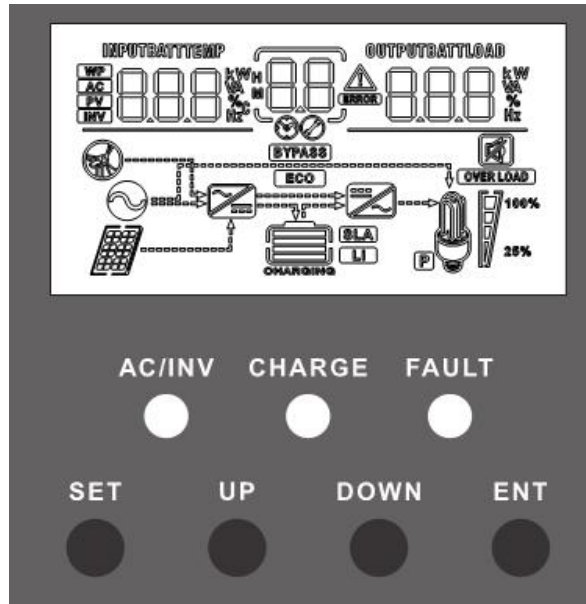

Indicators introduction

Indicator lights	Color	State	Description
AC/INV	Yellow	Always ON	Mains output
		Blinking	Inverter output
CHARGE	Green	Blinking	The battery is being charged
		Always ON	Charging is completed
FAULT	Red	Always ON	Fault state

Operation buttons introduction





Function buttons	Description
SET	Enter/Exit Settings menu
UP	Previous choice
DOWN	Next choice
ENT	Confirm/Enter Options under the settings menu





7.2.6 Inverter Real-time Data Viewing Method







On the LCD main screen, press the “UP” and “DOWN” buttons to scroll through the real-time data of the machine.









NO.	Parameters on the left side of the screen		Parameters on the right side of the screen	
	LCD Screen	Introduction	LCD Screen	Introduction
1	INPUT BATT V	Battery input voltage	OUTPUT LOAD V	Output load voltage
2	PV TEMP °C	PV charger heatsink temperature	PV OUTPUT KW	PV output power
3	PV INPUT V	PV input voltage	PV OUTPUT A	PV output current
4	INPUT BATT A	Input battery current	OUTPUT BATT A	Battery output current
5	INPUT BATT KW	Battery input power	OUTPUT BATT KW	Battery output power
6	AC INPUT Hz	AC input frequency	AC OUTPUT LOAD Hz	AC output frequency
7	AC INPUT V	AC input voltage	AC OUTPUT LOAD A	AC output load current
8	INPUT V	For maintain	OUTPUT LOAD KVA	Load apparent power
9	INV TEMP °C	AC charge or battery discharge heatsink temperature	INV OUTPUT LOAD KW	Load active power
10	888	APP software version	888	Bootloader software version
11	888	Model Battery Voltage Rating	888	Model Output Power Rating
12	888	Model PV Voltage Rating	888	Model PV Current Rating





7.2.7 PCS Parameter Adjustment









NO.	Parameter name	allow adjustment	Settings (default)	Description
[00]	Exit setting menu		ESC	Exit the setup menu
[01]	Work priority mode		SOL	PV priority mode, switching to the Mains when the PV fails or the battery is lower than the set value of parameter [04].
			UTI	Mains priority mode, switching to inverter only when the mains fails.
			SBU	Inverter priority mode, switching to the mains only when the battery is under voltage or lower than the set value of parameter [04].
[02]	Output Frequency		50.0	Bypass self-adaptation; when the mains is connected, it automatically adapts to the mains frequency; when the mains is disconnected, the output frequency can be set through this menu. The default output frequency of the 230V machine is 50HZ, and the 120V machine 60HZ.
			60.0	
[03]	AC Input Voltage Range		APL	Wide mains input voltage range of 230V machine: 90~280V Mains input voltage range of 120V machine: 90~140V
			UPS	Narrow mains input voltage range of 230V machine: 170~280V Mains input voltage range of 120V machine: 90~140V
[04]	Battery Power to Utility Setpoint		24.0V	When the parameter [01] =SOL/SBU, the battery voltage is lower than the set value, and the output is switched from the inverter to the mains. Setting range: 20V~26V.

NO.	Parameter name	allow adjustment	Settings (default)	Description
[05]	Utility to Battery Power Setpoint		27.6V	When the parameter [01] =SOL/SBU, the battery voltage is higher than the set value, and the output is switched from the mains to the inverter. Setting range: 24V~30V.
[06]	Charger source priority		CSO	PV priority charging; only when the PV charging fails, the mains charging is started.
			CUB	Mains priority charging; only when the mains charging fails, the PV charging is started.
			SNU	PV and Mains hybrid charging; PV charging is a priority, and when the PV energy is insufficient, the Mains charging supplements. When the PV energy is sufficient, the Mains charging stops. Note: Only when the Mains bypass output is loaded, the PV charging and the mains charging can work at the same time. When the inverter works, only the PV charging can be started.
			OSO	Only PV charging, with the Mains charging not activated.
[07]	Max charger current		80A	Setting range: 0~80A ;
[08]	Battery Type		LF07	7 strings LFP battery, charge voltage is 24.8V
			LF08	8 strings LFP battery, charge voltage is 28.4V
			LF09	9strings LFP battery, charge voltage is 31.8V
			NCA	7 strings NCM battery, charge voltage is 28.4V

NO.	Parameter name	allow adjustment	Settings (default)	Description
[09]	Battery boost charge voltage		28.4V	Boost charge voltage setting; the setting range is 24V~29.2V, with step of 0.2V; it is valid for user-defined battery and lithium battery.
[10]	Battery boost charge time		120	Boost charge maximum time setting, which means the maximum charging time to reach the set voltage of parameter [09] during constant-voltage charging. The setting range is 5min~900min, with a step of 5 minutes. It is valid for user-defined battery and lithium battery.
[11]	Battery floating charge voltage		28.4V	Floating charge voltage, setting range: 24V~29.2V, step: 0.2V, valid when battery type is user-defined.
[12]	Battery over discharge voltage (delay off)		23.4V	Over-discharge voltage; when the battery voltage is lower than this judgment point, delay the time set by parameter [13] and turn off inverter output. Setting range is 20V~24V, with a step of 0.2V. It is valid for user-defined battery and lithium battery.
[13]	Battery over discharge delay time		5S	Over-discharge delay time; when the battery voltage is lower than the parameter [12], the inverter output will be turned off after the time set by this parameter is delayed. The setting range is 5S~55S, with a step of 5S. It is valid for user-defined battery and lithium battery.
[14]	Battery under voltage alarm		24.8V	Battery undervoltage alarm point; when the battery voltage is lower than the point, an undervoltage alarm is given, and the output is not turned off; the setting range is 20V~26V, with a

NO.	Parameter name	allow adjustment	Settings (default)	Description
				step of 0.2V. It is valid for user-defined battery and lithium battery.
[15]	Battery discharge limit voltage		23.2V	Battery discharge limit voltage; when the battery voltage is lower than the point, the output is turned off immediately; the setting range is 20V~26V, with a step of 0.2V. It is valid for user-defined battery and lithium battery.
[16]	Battery equalization enable		DIS	Equalizing charge is disabled
			ENA	Equalizing charge is enabled, only valid for vented lead-acid battery and sealed lead-acid battery
[17]	Battery equalization voltage		29.2V	Equalizing charge voltage; setting range: 24V~29.2V, with a step of 0.2V; valid for vented lead-acid battery and sealed lead-acid battery
[18]	Battery equalized time		120	Equalizing charge time; setting range: 5min~900min, with a step of 5 minutes; valid for vented lead-acid battery and sealed lead-acid battery
[19]	Battery equalized time out		120	Equalizing charge delay; setting range: 5min~900min, with a step of 5 minutes; valid for vented lead-acid battery and sealed lead-acid battery
[20]	Battery equalization interval		30	Equalizing charge derating time, 0~30days, with a step of 1 day; valid for vented lead-acid battery and sealed lead-acid battery
[21]	Battery equalization immediately		DIS	Stop equalizing charge immediately.
			ENA	Start equalizing charge immediately.
[22]	Power saving mode		DIS	Power saving mode disabled.

NO.	Parameter name	allow adjustment	Settings (default)	Description
			ENA	After the power saving mode is enabled, if the load is null or less than 50W, the inverter output is turned off after a delay for a certain period of time. When the load is more than 50W, the inverter automatic restart.
[23]	Restart when over load		DIS	Automatic restart when overload is disabled. If an overload occurs and the output is turned off, the machine will not restart.
			ENA	Automatic restart when overload is enabled. If an overload occurs and the output is turned off, the machine will restart after a delay of 3 minutes. After it reaches 5 cumulative times, the machine will not restart.
[24]	Restart when over temperature		[24] DIS	Automatic restart when over temperature is disabled. If an over-temperature shutdown occurs, machine will not restart to turn the output on.
			ENA	Automatic restart when over temperature is enabled. If an over-temperature shutdown occurs, the machine will restart when the temperature drops.
[25]	Alarm enable		DIS	Alarm is disabled
			ENA	Alarm is enabled
[26]	Beeps while primary source is interrupted		DIS	Alarm beep is disabled when the status of the main input source changes
			ENA	Alarm beep is enabled when the status of the main input source changes
[27]	Bypass output		DIS	It is disabled to automatically switch

NO.	Parameter name	allow adjustment	Settings (default)	Description
	when over load			to the Mains when the inverter is overloaded.
			ENA	It is enabled to automatically switch to the Mains when the inverter is overloaded.
[28]	Max AC charger current		80A	AC Out 230Vac Setting range 0~80A
			40A	AC Out 120Vac Setting range 0~40A
[30]	RS485 Address setting		1	RS485 communication address setting range 1 ~ 254
[32]	RS485-1 communication		485	RS485-2 port for BMS communication.
[33]	Battery BMS communication protocol		WOW	you can choose to match the battery manufacturer's BMS protocol to communicate with BMS for the lithium battery protection.
[35]	Battery overdischarge recovery point		26V	When the battery voltage is overdischarge voltage, the battery voltage needs to recover more than this set value before the inverter starts the output
[36]	Max PV charger current		60A	PV charge current setting range : 0~60A
[37]	Battery fully charged recovery point		26.4V	After the battery is fully charged, it needs to be lower than this set voltage before it can be recharged
[38]	AC output voltage setting		220V	Settable : (200/208/220/240Vac)
			110V	Settable : (100/105/110Vac)

7.3 Install The Cover Plate

When all wiring is complete and the system is operating normally, close the side cover.

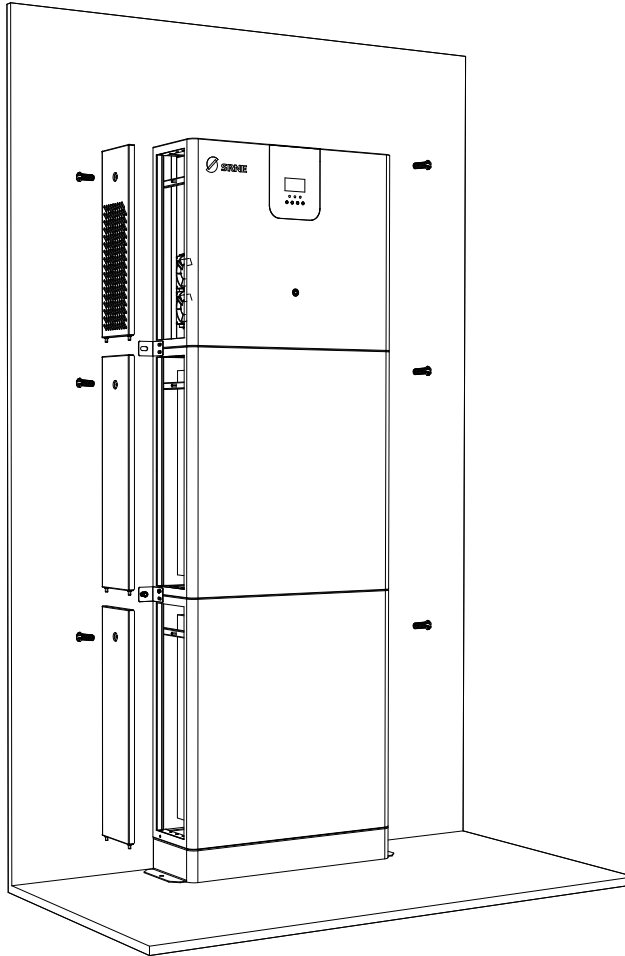

8 System Maintenance

8.1 System Power-Off



After the system is powered off, the case still has residual power and heat, which may cause electric shocks or burns. Therefore, protective gloves should be worn before operating the energy storage 5 minutes after the system is powered off. Maintenance operations on energy storage should be performed only after ensuring that all indicator lights of the energy storage are off.

Power-off operation steps of the system:

Step 1 Turn off the breaker switch between the inverter and AC output (If installed).

Step 2 Turn off the breaker switch between the inverter unit and AC input(If installed).

Step 3 Turn off the breaker switch between the inverter unit and the PV string(If installed).

Step 4 Turn off the battery breaker switch, all LED indicators are off.

Step 5 Turn off button on all storage battery modules, the energy storage is powered off successfully.

8.2 Routine Maintenance

To ensure the long-term and good operation of the energy storage system, it is recommended to perform the routine maintenance as described in this section.

Items	Methods	Maintenance interval
System cleanliness	Check if the radiator is covered or dirt on a regular basis.	Once every six months to one year.
Running status of system	<ul style="list-style-type: none"> • Observe whether the energy storage appearance is damaged or deformed. • Listen to whether the energy storage has any abnormal sound during running. • When the energy storage is running, check whether the indicator of the energy storage battery is correct. 	Once every six months.
Electrical connection	<ul style="list-style-type: none"> • Check if any cable connection is off or loose. • Check if any cable is damaged, and especially if there are cuts on the sheath where the cable contacts with the metal surface. • Check if the unused DC input terminals, energy storage terminals, COM ports, and covers are locked. 	Half a year after first debugging and testing, and once every six months to one year thereafter.
Grounding reliability	Check if the grounding cable is grounded reliably.	Half a year after first debugging and testing, and once every six months to one year thereafter.

8.3 Troubleshooting

8.3.1 Fault Code and Handling Methods

Fault code	Fault name	Whether it affects the output or not	Description
【01】	BatVoltLow	No	Battery undervoltage alarm
【02】	BatOverCurrSw	Yes	Battery discharge average current overcurrent software protection
【03】	BatOpen	Yes	Battery not-connected alarm
【04】	BatLowEod	Yes	Battery undervoltage stop discharge alarm
【05】	BatOverCurrHw	Yes	Battery overcurrent hardware protection
【06】	BatOverVolt	Yes	Charging overvoltage protection
【07】	BusOverVoltHw	Yes	Bus overvoltage hardware protection
【08】	BusOverVoltSw	Yes	Bus overvoltage software protection
【09】	PvVoltHigh	No	PV overvoltage protection
【10】	PvBuckOCSw	No	Buck overcurrent software protection
【11】	PvBuckOCHw	No	Buck overcurrent hardware protection
【12】	bLineLoss	No	Mains power down
【13】	OverloadBypass	Yes	Bypass overload protection
【14】	OverloadInverter	Yes	Inverter overload protection
【15】	AcOverCurrHw	Yes	Inverter overcurrent hardware protection
【17】	InvShort	Yes	Inverter short circuit protection
【19】	OverTemperMppt	No	Buck heat sink over temperature protection
【20】	OverTemperInv	Yes	Inverter heat sink over temperature protection
【21】	FanFail	Yes	Fan failure
【22】	EEPROM	Yes	Memory failure
【23】	ModelNumErr	Yes	Model setting error
【26】	RlyShort	Yes	Inverted AC Output Backfills to Bypass AC Input
【29】	BusVoltLow	Yes	Internal battery boost circuit failure
【30】	BatSocLow1	No	Battery Soc < 10%
【31】	BatSocLow2	No	Battery Soc < 5%
【32】	BatSocLowStop	Yes	Battery Soc < 1%, Turn off the inverter
【60】	BmsBatTempLow	No	Battery low temperature warning
【61】	BmsBatTempHigh	No	Battery high temperature warning
【62】	BmsBatOverCurr	No	Battery over current warning
【63】	BmsBatVoltLow	No	Battery low voltage warning
【64】	BmsBatOverVolt	No	Battery over voltage warning

8.3.2 Common Faults and Handling Methods

Faults	Handling measures
No display on the screen	Check if the battery air switch or the PV air switch has been closed; if the switch is in the "ON" state; press any button on the screen to exit the screen sleep mode.
Battery overvoltage protection	Measure if the battery voltage exceeds rated, and turn off the PV array air switch and Mains air switch.
Battery undervoltage protection	Charge the battery until it returns to the low voltage disconnection recovery voltage.
Fan failure	Check if the fan is not turning or blocked by foreign object.
Heat sink over temperature protection	When the temperature of the device is lower than the recovery temperature, normal charge and discharge control is resumed.
Bypass overload protection, inverter overload protection	① Reduce the use of power equipment; ② Restart the unit to resume load output.
Inverter short circuit protection	① Check the load connection carefully and clear the short-circuit fault points; ② Re-power up to resume load output.
PV overvoltage	Use a multimeter to check if the PV input voltage exceeds the maximum allowable input voltage rated.
Battery missed alarm	Check if the battery is not connected or if the battery circuit breaker is not closed.

8.4 Battery Storage and Maintenance

8.4.1 Battery Storage Requirements



Do not put the battery into fire. The battery may explode.

Do not open or damage the battery. The electrolyte flowing out from the battery is harmful to the skin and eyes. The electrolyte may also be toxic;

1. When being stored, the batteries shall be placed correctly in accordance with the marks on the packing case. Do not put them upside down or on the side.
2. When stacking up the battery packing cases, the stacking requirements on the outer package shall be met.
3. The batteries should be handled with care, and damage to batteries should be strictly prohibited.
4. Requirements for the storage environment:
 - Ambient temperature: -10°C to 55 °C, recommended storage temperature: 20°C to 30°C.
 - Relative humidity: 5%RH-80%RH.
 - Dry, well ventilated, and clean.

- The corrosive organic solvents, gases and other substances shall be kept away.
 - Exposing to direct sunlight shall be avoided.
 - The distance from the heat source should not be less than two meters.
5. When being stored, the battery shall be disconnected from the external connection. If there is an indicator light on the battery panel, the indicator light shall be off.
 7. The warehouse keeper shall make monthly statistics on the battery storage, and regularly inform the planning link of the battery inventory. If any battery has been stored for nearly 15 months ($-10\text{ }^{\circ}\text{C}$ to $25\text{ }^{\circ}\text{C}$), 9 months ($25\text{ }^{\circ}\text{C}$ to $35\text{ }^{\circ}\text{C}$), or 6 months ($35\text{ }^{\circ}\text{C}$ to $55\text{ }^{\circ}\text{C}$), recharging shall be arranged in time.
 8. When the stored batteries are going to be delivered, the first-in first-out principle should be followed.
 9. After the battery is produced and tested, it shall be recharged to at least 50% SOC before being stored. If the device will not be used for a long period of time, discharge the battery to 45% to 60% of the battery capacity and disconnect the battery output to avoid the battery runs out;
 10. Do not touch the battery pack with wet hands.
 11. Do not squeeze, drop, or pierce the battery.
 12. The battery should always be disposed in accordance with local safety regulations.
 13. The battery should be stored and recharged in accordance with this User's Manual.
 14. Do not reverse polarity of the battery when storing or transporting the batteries, the batteries shall not be stacked up without protective packaging, and the number of stacked packed batteries should not exceed the number specified on the packaging.
 15. All operators of the energy storage system shall comply with the user manual, installation and service manual, and quality assurance requirements. Any damage to the device resulting from neglecting or misreading of the user's manual, installation and service manual, and the quality assurance requirements will invalidate the product warranty.

8.4.2 Requirements for Charging of Battery

The batteries to be stored for a long period of time (unused, for more than 3 months) must be kept in a dry and cool place. The storage voltage is 51V-53V. The batteries should be stored in a clean environment of $23\pm 2\text{ }^{\circ}\text{C}$ and humidity of 45%-75%. If the battery will be shelved and not used for a long period of time, it should be recharged every 3 months to ensure that the battery voltage is within the above range.

As for batteries and long-term storage, routine maintenance is required. Please charge the battery to 40% SOC at a current of 0.2C according to the requirements in the table below.

Ambient temperature for storage	Relative humidity for storage environment	Storage Time	SOC
$<-10\text{ }^{\circ}\text{C}$	/	Prohibited	/
$-10\sim 25\text{ }^{\circ}\text{C}$	5%~70%	≤ 12 months	$30\%\leq\text{SOC}\leq 60\%$
$25\sim 35\text{ }^{\circ}\text{C}$		≤ 6 months	
$35\sim 45\text{ }^{\circ}\text{C}$		≤ 3 months	
$>45\text{ }^{\circ}\text{C}$	/	Prohibited	/

8.5 Device Cleaning

It is recommended to clean and maintain the product from time to time. When cleaning, the dust and stains on the product shall be removed with a piece of soft dry cloth or vacuum cleaner, especially when cleaning the heat dissipation and air vents on both sides of the product. The product shall not be cleaned with organic solvents, corrosive liquids and other cleaning products.

If the fan fails, it can be replaced by a professional.

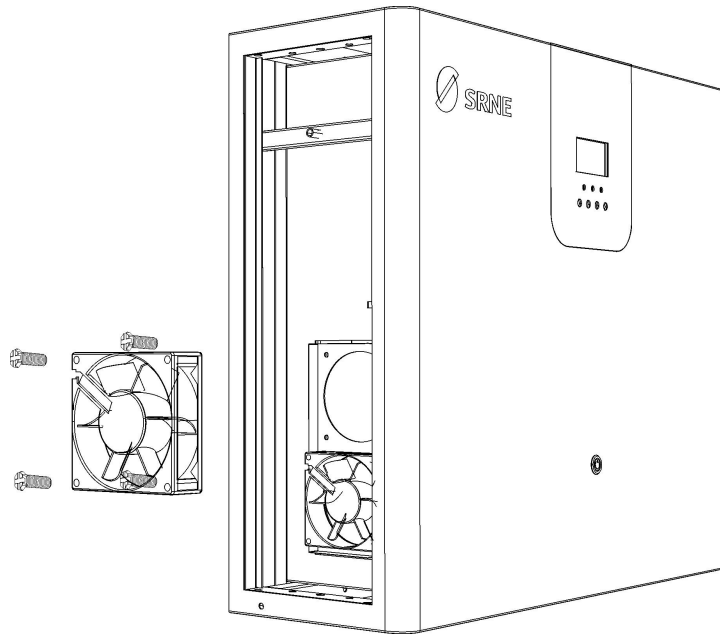

9 Technical Data

9.1 Power Module Data

		SR-EOV24-3.5S-C0	SR-EOV24-3.5U-C0
Battery Inverter	Rated Output Power	3500W	3500W
	Maximum Peak Power	6000VA	6000VA
	Power Factor	1	1
	Rated Output Voltage (Vac)	230Vac	120Vac
	Frequency	50Hz	60Hz
	Auto Switch Period	< 10ms	< 10ms
	THD	< 3%	< 3%
AC Charge	Maximum AC Charge Power	2240W	1120W
	AC Charging Current Range	0 ~ 80A	0 ~ 40A
	Rated Input Voltage	220/230Vac	110/120Vac
	Input Voltage Range	90 ~ 280Vac	90 ~ 140Vac
AC Output	Rated Output Power	3500W	3500W
	Maximum Output Current	30A	40A
	Frequency	50Hz	60Hz
	Overload Current	35A	45A
PV Charge	Solar Charge Type	MPPT	MPPT
	Maximum Output Power	4000W	4000W
	PV Charging Current Range	0 ~ 80A	0 ~ 80A
	PV Operating Voltage Range	120 ~ 500V	120 ~ 500V
	MPPT Voltage Range	120 ~ 450V	120 ~ 450V
General Data	Operating Temperature Range	-15°C ~ 55°C	-15°C ~ 55°C
	Storage Temperature Range	-25°C ~ 60°C	-25°C ~ 60°C
	Humidity Range	5% to 95%	5% to 95%
	Nominal Operation Altitude	< 2000m	< 2000m
	Cooling Mode	Force-Air Cooling	Force-Air Cooling
	Noise	60dB(A)	60dB(A)
	Ingress Protection Rating	IP20	IP20
	Certification	CE(EN62109-1)	CE(EN62109-1)
	EMC Certification Level	EN61000, C2	EN61000, C2
	Gross Weight	30Kg	30Kg
	Dimension L× D× H	600×184×500	600×184×500

9.2 Battery Module Data

Battery Type	LiFePO4
Battery Energy	5.12kWh
Battery Capacity	200AH
Battery Rated Voltage	25.6V
Battery Working Voltage Range	22.4 ~ 28.8V
Maximum Charging Current	150A
Maximum Discharging Current	150A
DOD	80%
Parallel Quantity	4
Designed Life-span	5000
Operating Temperature	Charge : 0 ~ 45°C Discharge : -10 ~ 45°C
Operation Humidity	5% ~ 85%
Nominal Operation Altitude	< 3000m
Ingress Protection Rating	IP20
Recommended Operation Environment	Indoor
Installation Method	Vertical
Gross Weight	70kg
Dimension L× D× H	600×184×610

10 Product Dimensions and Packaging

10.1 Product Dimensions

The external dimensions of the inverter module is 600*184*500mm, the external dimensions of the energy storage battery module is 600*184*500mm, the external dimensions of the base module is 680*184*80mm.

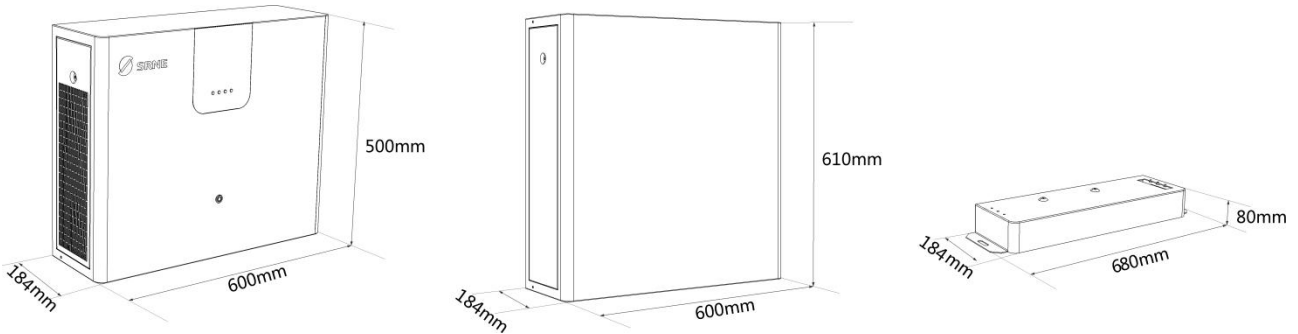

10.2 Package Dimensions



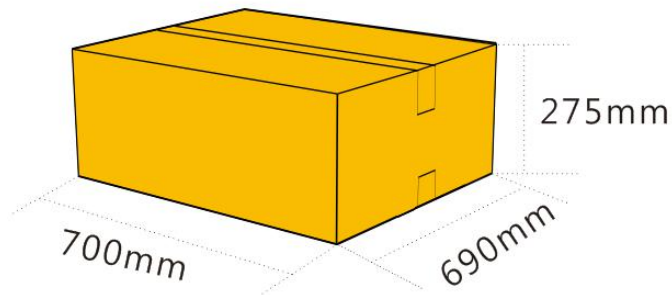

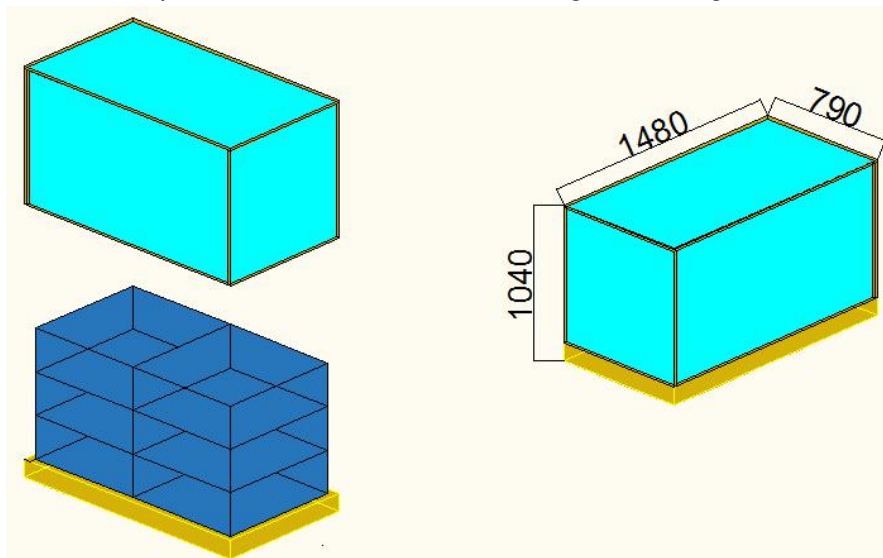

The packaging size of a single energy storage battery module and Inverter module is 700*690*275mm.



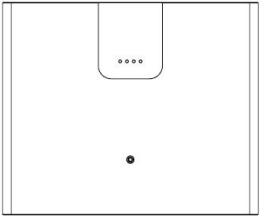
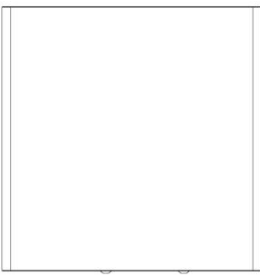

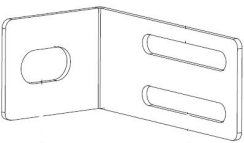
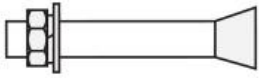
The energy storage battery module and Inverter module are packed in wooden cases with the size of 1,480*1,040*790, the number of packs is 6 PCS, and the total weight is 500Kg.

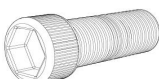

10.3 Packaging List

NO.	Picture	Item	Quantity	Specification	Source
1		Inverter	1	3.5kW/24V,110V/220V	Inverter Package
2		Battery	1	5.12kWh/25.6V	Battery Package
3		Base	1	680*184*80mm	Inverter Package
4		Mounting Frame	2	80*44mm	Battery Package
5		Mounting Frame Screw	4	M8*60 expansion bolt	Battery Package
6		Screw	6	M5*10	Battery Package
7		Fixing screw	2	M6*35	Battery Package
8		Hexagon wrench	1	120*30mm	Battery Package

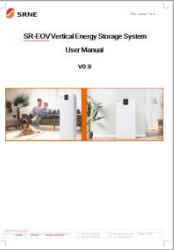
9		Power cable	1	560mm,4AWG	Battery Package
10		Signal cable	1	700mm	Battery Package
11		User Manual	1		Inverter Package