

User Manual

AIO SERIES

In order to prevent improper operation before use, please carefully read this manual.

Table of Contents

| | | |
|------|--|----|
| 1. | Notes on This Manual..... | 1 |
| 1.1 | Scope of Validity..... | 1 |
| 1.2 | Target Group..... | 1 |
| 1.3 | Symbols Used..... | 1 |
| 2. | Safety..... | 2 |
| 2.1 | Appropriate Usage..... | 2 |
| 2.2 | PE Connection and Leakage Current..... | 3 |
| 2.3 | Surge Protection Devices (SPDs) for PV Installation..... | 3 |
| 3. | Introduction..... | 4 |
| 3.1 | Basic Features..... | 4 |
| 3.2 | Dimensions..... | 5 |
| 3.3 | Terminals of Energy Station..... | 6 |
| 4. | Technical Data..... | 7 |
| 4.1 | PV Input (For AIO-H1 Only)..... | 7 |
| 4.2 | AC Output/Input..... | 7 |
| 4.3 | EPS Output..... | 9 |
| 4.4 | Efficiency, Protection and Standard..... | 10 |
| 4.5 | Battery..... | 11 |
| 4.6 | General Data..... | 11 |
| 5. | Installation..... | 12 |
| 5.1 | Check for Physical Damage..... | 12 |
| 5.2 | Packing List..... | 12 |
| 5.3 | Mounting..... | 13 |
| 6. | Electrical Connection..... | 17 |
| 6.1 | PV Connection (For AIO-H1 Only)..... | 17 |
| 6.2 | Battery Connection..... | 19 |
| 6.3 | Grid Connection..... | 21 |
| 6.4 | Earth Connection..... | 24 |
| 6.5 | Communication Device Installation (Optional)..... | 24 |
| 6.6 | EPS Connection..... | 30 |
| 6.7 | Energy Station Start-Up..... | 32 |
| 6.8 | Energy Station Switch Off..... | 33 |
| 7. | Firmware Upgrading..... | 33 |
| 8. | Operation..... | 34 |
| 8.1 | Control Panel..... | 34 |
| 8.2 | Function Tree..... | 35 |
| 9. | Maintenance..... | 35 |
| 9.1 | Alarm List..... | 35 |
| 9.2 | Troubleshooting and Routine Maintenance..... | 41 |
| 10. | Decommissioning..... | 42 |
| 10.1 | Dismantling the Energy Station..... | 42 |
| 10.2 | Packaging..... | 42 |
| 10.3 | Storage and Transportation..... | 42 |

1. Notes on This Manual

1.1 Scope of Validity

This manual describes the assembly, installation, commissioning, maintenance and troubleshooting of the following model(s) of Fox products:

| | | | |
|--------------------|--------------------|---------------------|-------------|
| AIO-H1-3.0 | AIO-H1-3.7 | AIO-H1-4.6 | |
| AIO-H1-5.0-HVS5.2 | AIO-H1-5.0-HVS7.8 | AIO-H1-5.0-HVS10.4 | AIO-H1-5.0 |
| AIO-H1-6.0-HVS5.2 | AIO-H1-6.0-HVS7.8 | AIO-H1-6.0-HVS10.4 | AIO-H1-6.0 |
| AIO-AC1-3.0 | AIO-AC1-3.7 | AIO-AC1-4.6 | |
| AIO-AC1-5.0-HVS5.2 | AIO-AC1-5.0-HVS7.8 | AIO-AC1-5.0-HVS10.4 | AIO-AC1-5.0 |
| AIO-AC1-6.0-HVS5.2 | AIO-AC1-6.0-HVS7.8 | AIO-AC1-6.0-HVS10.4 | AIO-AC1-6.0 |





Note: Please keep this manual where it will be accessible at all times.

1.2 Target Group



This manual is for qualified electricians. The tasks described in this manual only can be performed by qualified electricians.





1.3 Symbols Used

The following types of safety instructions and general information appear in this document as described below:

| | |
|---|---|
|  | Danger! “Danger” indicates a hazardous situation which, if not avoided, will result in death or serious injury. |
|  | Warning! “Warning” indicates a hazardous situation which, if not avoided, could result in death or serious injury. |
|  | Caution! “Caution” indicates a hazardous situation which, if not avoided, could result in minor or moderate injury. |
|  | Note! “Note” provides important tips and guidance. |

This section explains the symbols shown on the energy station and on the type label:

| Symbols | Explanation |
|---|--|
|  | Symbol Explanation CE mark. The energy station complies with the requirements of the applicable CE guidelines. |
|  | Beware of hot surface. The energy station can become hot during operation. Avoid contact during operation. |
|  | Danger of high voltages. Danger to life due to high voltages in the energy station! |

| | |
|---|---|
|  | Danger. Risk of electric shock! |
|  | Danger to life due to high voltage. There is residual voltage in the energy station which needs 5 min to discharge. Wait 5 min before you open the upper lid or the DC lid. |
|  | Read the manual. |
|  | Product should not be disposed as household waste. |

2. Safety

2.1 Appropriate Usage

AIO series energy stations are designed and tested in accordance with international safety requirements. However, certain safety precautions must be taken when installing and operating this energy station. The installer must read and follow all instructions, cautions and warnings in this installation manual.

- All operations including transport, installation, start-up and maintenance, must be carried out by qualified, trained personnel.
- The electrical installation & maintenance of the energy station shall be conducted by a licensed electrician and shall comply with local wiring rules and regulations.
- Before installation, check the unit to ensure it is free of any transport or handling damage, which could affect insulation integrity or safety clearances. Choose the installation location carefully and adhere to specified cooling requirements. Unauthorized removal of necessary protections, improper use, incorrect installation and operation may lead to serious safety and shock hazards or equipment damage.
- Before connecting the energy station to the power distribution grid, contact the local power distribution grid company to get appropriate approvals. This connection must be made only by qualified technical personnel.
- Do not install the equipment in adverse environmental conditions such as in close proximity to flammable or explosive substances; in a corrosive or desert environment; where there is exposure to extreme high or low temperatures; or where humidity is high.
- Do not use the equipment when the safety devices do not work or are disabled.
- Use personal protective equipment, including gloves and eye protection during the installation.
- Inform the manufacturer about non-standard installation conditions.
- Do not use the equipment if any operating anomalies are found. Avoid temporary repairs.
- All repairs should be carried out using only approved spare parts, which must be installed in accordance with their intended use and by a licensed contractor or authorized Fox service representative.
- Liabilities arising from commercial components are delegated to their respective manufacturers.
- Any time the energy station has been disconnected from the public network, please be extremely

cautious as some components can retain charge sufficient to create a shock hazard. Prior to touching any part of the energy station please ensure surfaces and equipment are under touch safe temperatures and voltage potentials before proceeding.

2.2 PE Connection and Leakage Current

PV System Residual Current Factors

- In every PV installation, several elements contribute to the current leakage to protective earth (PE). these elements can be divided into two main types.
- Capacitive discharge current - Discharge current is generated mainly by the parasitic capacitance of the PV modules to PE. The module type, the environmental conditions (rain, humidity) and even the distance of the modules from the roof can effect the discharge current. Other factors that may contribute to the parasitic capacitance are the inverter's internal capacitance to PE and external protection elements such as lighting protection.
- During operation, the DC bus is connected to the alternating current grid via the inverter. Thus, a portion of the alternating voltage amplitude arrives at the DC bus. The fluctuating voltage constantly changes the charge state of the parasitic PV capacitor (i.e capacitance to PE). This is associated with a displacement current, which is proportional to the capacitance and the applied voltage amplitude.
- Residual current - if there is a fault, such as defective insulation, where an energized cable comes into contact with a grounded person, an additional current flows, known as a residual current.

Residual Current Device (RCD)

- All Fox inverters incorporate a certified internal RCD (Residual Current Device) to protect against possible electrocution in case of a malfunction of the PV array, cables or inverter (DC). The RCD in the Fox inverter can detect leakage on the DC side. There are 2 trip thresholds for the RCD as required by the DIN VDE 0126-1-1 standard. A low threshold is used to protect against rapid changes in leakage typical of direct contact by people. A higher threshold is used for slowly rising leakage currents, to limit the current in grounding conductors for the safety. The default value for higher speed personal protection is 30mA, and 300mA per unit for lower speed fire safety.

Installation and Selection of an External RCD device

- An external RCD is required in some countries. The installer must check which type of RCD is required by the specific local electric codes. Installation of an RCD must always be conducted in accordance with local codes and standards. Fox recommends the use of a type-A RCD. Unless a lower value is required by the specific local electric codes, Fox suggests an RCD value between 100mA and 300mA.
- In installations where the local electric code requires an RCD with a lower leakage setting, the discharge current might result in nuisance tripping of the external RCD. The following steps are recommended to avoid nuisance tripping of the external RCD:
 1. Selecting the appropriate RCD is important for correct operation of the installation. An RCD with a rating of 30mA may actually trip at a leakage as 15mA (according to IEC 61008). High quality RCDs will typically trip at a value closer to their rating.
 2. Configure the trip current of the inverter' internal RCD to a lower value than the trip current of the external RCD. The internal RCD will trip if the current is higher than the allowed current, but because the internal inverter RCD automatically resets when the residual currents are low it saves the manual reset.

2.3 Surge Protection Devices (SPDs) for PV Installation

WARNING!

Over-voltage protection with surge arresters should be provided when the PV power system is installed. The grid connected energy station is not fitted with SPDs in both PV input side and mains side.

Lightning will cause damage either from a direct strike or from surges due to a nearby strike.

Induced surges are the most likely cause of lightning damage in majority of installations, especially in rural areas where electricity is usually provided by long overhead lines. Surges may impact on both the PV array conduction and the AC cables leading to the building. Specialists in lightning protection should be consulted during the end use application. Using appropriate external lightning protection, the effect of a direct lightning strike into a building can be mitigated in a controlled way, and the lightning current can be discharged into the ground.

Installation of SPDs to protect the energy station against mechanical damage and excessive stress include a surge arrester in case of a building with external lightning protection system (LPS) when separation distance is kept. To protect the DC system, surge suppression device (SPD type2) should be fitted at the energy station end of the DC cabling and at the array located between the energy station and the PV generator, if the voltage protection level (VP) of the surge arresters is greater than 1100V, an additional SPD type 3 is required for surge protection for electrical devices.

To protect the AC system, surge suppression devices (SPD type2) should be fitted at the main incoming point of AC supply (at the consumer's cutout), located between the energy station and the meter/distribution system; SPD (test impulse D1) for signal line according to EN 61632-1. All DC cables should be installed to provide as short a run as possible, and positive and negative cables of the string or main DC supply should be bundled together.

Avoiding the creation of loops in the system. This requirement for short runs and bundling includes any associated earth bundling conductors. Spark gap devices are not suitable to be used in DC circuits once conducting; they won't stop conducting until the voltage across their terminals is typically below 30 volts.

3. Introduction

3.1 Basic Features

AIO series are high-quality energy station which can convert solar energy to AC energy and store energy into battery. The energy station can be used to optimize self-consumption, store in the battery for future use or feed-in to public grid. Work mode depends on PV energy and user's preference.

- System advantages:
 - Advanced DSP control technology.
 - Utilizes the latest high-efficiency power component.
 - Advanced anti-islanding solutions.
 - IP65 protection level.
 - Max. Efficiency up to 97.8%. EU efficiency up to 97.0%. THD<3%.
 - Safety & Reliability: Transformerless design with software and hardware protection.
 - Export limitation (CT/Meter/DRM0/ESTOP).
 - Power factor regulation. Friendly HMI.
 - LED status indications.
 - LCD display technical data, human-machine interaction through four touch keys.
 - PC remote control.

- Work modes:

| Work modes | Description |
|--------------------------------|--|
| Self-use (with PV Power) | Priority: load>battery>grid The energy produced by the PV system is used to optimize self-consumption. The excess energy is used to charge the batteries, then exported to grid. |
| Self-use (without PV Power) | When no PV supplied, battery will discharge for local loads firstly, and grid will supply power when the battery capacity is not enough. |
| Feed in priority | Priority: load>grid>battery In the case of the external generator, the power generated will be used to supply the local loads firstly, then export to the public grid. The redundant power will charge the battery. |
| Force time use | Priority: battery>load>grid (when charging) Priority: load>battery>grid (when discharging) This mode applies the area that has electricity price between peak and valley. User can use off-peak electricity to charge the battery. The charging and discharging time can be set flexibly, and it also allows to choose whether charge from the grid or not. |
| Back up mode | When the grid is off, system will supply emergency power from PV or battery to supply the home loads (Battery is necessary in EPS mode). |

3.2 Dimensions

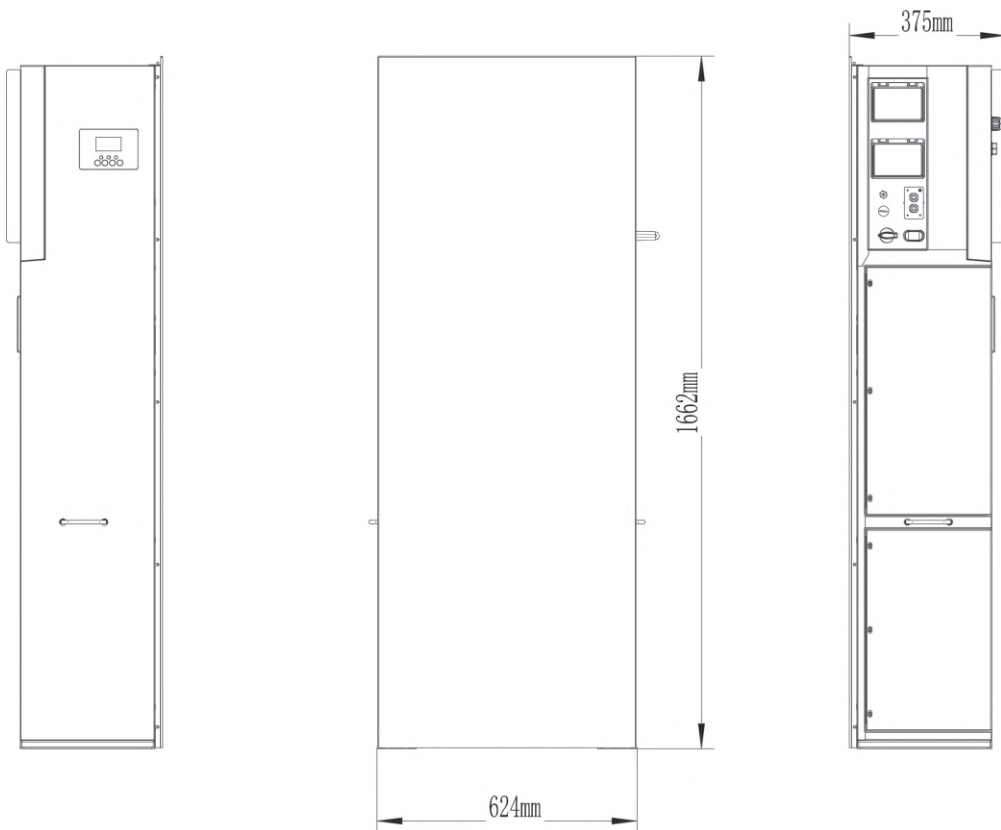

3.3 Terminals of Energy Station

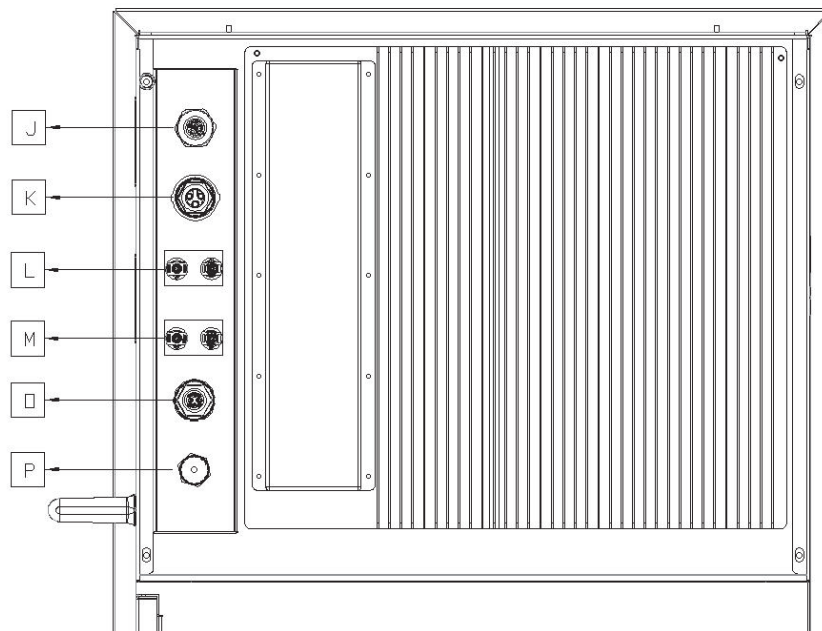
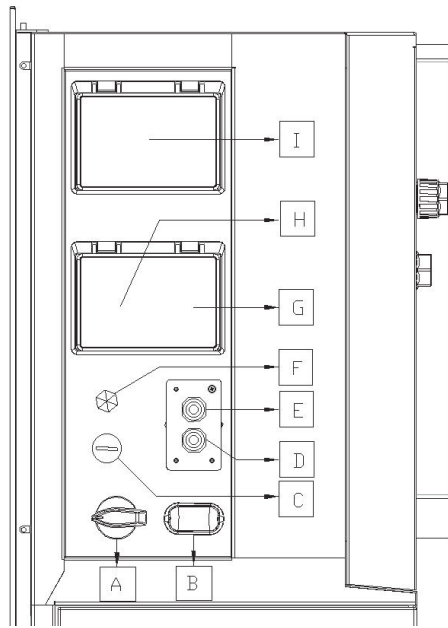

| Item | Description | Item | Description |
|------|-----------------------|------|-----------------|
| A | DC Switch | I | Battery Breaker |
| B | WiFi / GPRS | J | EPS |
| C | USB | K | ON-GRID |
| D | COM | L | PV1 |
| E | DRM | M | PV2 |
| F | Waterproof Lock Valve | O | METER/CT/RS485 |
| G | ON-GRID Breaker | P | Ethernet |
| H | EPS Breaker | | |

4. Technical Data

4.1 PV Input (For AIO-H1 Only)

| Model | AIO-H1-3.0 | AIO-H1-3.7 | AIO-H1-4.6 | AIO-H1-5.0 | | AIO-H1-6.0 | |
|--|-----------------|------------|------------|--------------------|--------------------|------------|--|
| | | | | AIO-H1-5.0-HVS5.2 | AIO-H1-6.0-HVS5.2 | | |
| | | | | AIO-H1-5.0-HVS7.8 | AIO-H1-6.0-HVS7.8 | | |
| | | | | AIO-H1-5.0-HVS10.4 | AIO-H1-6.0-HVS10.4 | | |
| PV | | | | | | | |
| Max. recommended DC power [W] | 3900 | 4680 | 5980 | 6500 | 7800 | | |
| Max. DC voltage [V] | 600 | | | | | | |
| Nominal DC operating voltage [V] | 360 | | | | | | |
| Max. input current (input A / input B) [A] | A:13.5 / B:13.5 | | | | | | |
| Max. short circuit current (input A / input B) [A] | A:15 / B:15 | | | | | | |
| Max. energy station backfeed current to the array [mA] | 0 | | | | | | |
| MPPT voltage range [V] | 80-550 | 80-550 | 80-550 | 80-550 | 80-550 | | |
| Start-up voltage [V] | 75 | 75 | 75 | 75 | 75 | | |
| No. of MPP trackers | 2 | 2 | 2 | 2 | 2 | | |
| Strings per MPP tracker | 1 | 1 | 1 | 1 | 1 | | |
| DC disconnection switch | Optional | | | | | | |

4.2 AC Output/Input

| Model | AIO-AC1-3.0 AIO-H1-3.0 | AIO-AC1-3.7 AIO-H1-3.7 | AIO-AC1-4.6 AIO-H1-4.6 | AIO-AC1-5.0-HVS5.2 AIO-AC1-6.0-HVS5.2 | AIO-AC1-5.0 | | AIO-AC1-6.0 | |
|---|------------------------------|---------------------------|---------------------------|--|---------------------|---------------------|-------------|--|
| | | | | | AIO-AC1-5.0-HVS7.8 | AIO-AC1-6.0-HVS7.8 | | |
| | | | | | AIO-AC1-5.0-HVS10.4 | AIO-AC1-6.0-HVS10.4 | | |
| | | | | | AIO-H1-5.0 | AIO-H1-6.0 | | |
| | | | | | AIO-H1-5.0-HVS5.2 | AIO-H1-6.0-HVS5.2 | | |
| | | | | | AIO-H1-5.0-HVS7.8 | AIO-H1-6.0-HVS7.8 | | |
| | | | | | AIO-H1-5.0-HVS10.4 | AIO-H1-6.0-HVS10.4 | | |
| | | | | | AC OUTPUT | | | |
| Nominal AC power [VA] | 3000 | 3680 | 4600 | 4000 | 5000 | 6000 | | |
| Max. apparent AC power [VA] | 3300 | 3680/4048 (1) | 4600/5060 (2) | 4400 | 5500 | 6000/6600 (4) | | |
| Rated grid voltage (AC voltage range) [V] | 220 / 230 / 240 (180 to 270) | | | | | | | |

| | | | | | | |
|---|------------------------------|-----------------------|-----------------------|-----------------------|-----------------------|-----------------------|
| Rated grid frequency [Hz] | 50 / 60, ±5 | | | | | |
| Nominal AC current [A] | 13 | 16 | 20 | 17.4 | 21.7 | 26.1 |
| Max. AC current [A] | 14.4 | 16/17.6 (3) | 22 | 19.2 | 23.9 | 26.1/28.7 (5) |
| Inrush current | 9.6A@50us | | | | | |
| Maximum output fault current[A] | 130A@ 10us | | | | | |
| Maximum output over current protection (A) | 35 | 36.7 | 45.8 | 43 | 47.7 | 57.4 |
| Displacement power factor | 0.8 leading to 0.8 lagging | | | | | |
| Total harmonic distortion (THDi, rated power) | <3% | | | | | |
| AC INPUT | | | | | | |
| Max.AC power [VA] | 3000+4000 (Bypass) | 3680+4000 (Bypass) | 4600+5000 (Bypass) | 4000+5000 (Bypass) | 5000+5000 (Bypass) | 6000+6000 (Bypass) |
| Max. AC current [A] | 31.8 | 34.9 | 43.7 | 43 | 45.5 | 54.6 |
| Rated grid voltage (AC voltage range) [V] | 220 / 230 / 240 (180 to 270) | | | | | |
| Rated grid frequency [Hz] | 50 / 60, ±5 | | | | | |
| Displacement power factor | 0.8 leading to 0.8 lagging | | | | | |

Note: [1] 3680 for G98,4048 for other country, [2] 4600 for VDE-AR-N 4105,5060 for other country
[3] 16for G98,17.6 for other country, [4][5] 28.7 for Italy, Thailand and Australia.

4.3 EPS Output

| Model | AIO-AC1-3.0 AIO-H1-3.0 | AIO-AC1-3.7 AIO-H1-3.7 | AIO-AC1-4.6 AIO-H1-4.6 | AIO-AC1-5.0-HVS5.2 AIO-AC1-6.0-HVS5.2 | AIO-AC1-5.0 | AIO-AC1-6.0 |
|---|---------------------------|---------------------------|---------------------------|--|---|---|
| | | | | | AIO-AC1-5.0-HVS7.8 AIO-AC1-5.0-HVS10.4 | AIO-AC1-6.0-HVS7.8 AIO-AC1-6.0-HVS10.4 |
| EPS OUTPUT (WITH BATTERY) | | | | | | |
| Max. EPS power [VA] | 5000 | 5000 | 6000 | 4000 | 6000 | 6600 |
| EPS rated voltage[V], Frequency [Hz] | 230VAC, 50 / 60 | | | | | |
| Max. EPS current [A] | 21.7 | 21.7 | 26.1 | 19.2 | 26.1 | 26.1 |
| EPS peak power[W] | 6000,60s | | 7200,10s | | | |
| Displacement power factor | 0 to 1* | | | | | |
| Switch time [s] | <20ms | | | | | |
| Total harmonic distortion (THDv, linear load) | <2% | | | | | |
| Compatible with the generator | Yes | | | | | |

*: Both inductive and capacitive loads can be connected, and the current and power for starting with load do not exceed the specified value.

4.4 Efficiency, Protection and Standard

| Model | AIO-AC1-3.0 AIO-H1-3.0 | AIO-AC1-3.7 AIO-H1-3.7 | AIO-AC1-4.6 AIO-H1-4.6 | AIO-AC1-5.0-HVS5.2 AIO-AC1-6.0-HVS5.2 | AIO-AC1-5.0 AIO-AC1-5.0-HVS7.8 AIO-AC1-5.0-HVS10.4 AIO-H1-5.0 AIO-H1-5.0-HVS5.2 AIO-H1-5.0-HVS7.8 AIO-H1-5.0-HVS10.4 | AIO-AC1-6.0 AIO-AC1-6.0-HVS7.8 AIO-AC1-6.0-HVS10.4 AIO-H1-6.0 AIO-H1-6.0-HVS5.2 AIO-H1-6.0-HVS7.8 AIO-H1-6.0-HVS10.4 |
|--|--|---------------------------|---------------------------|--|--|--|
| EFFICIENCY | | | | | | |
| MPPT efficiency | 99.90% | 99.90% | 99.90% | 99.90% | 99.90% | 99.90% |
| Euro-efficiency | 97.00% | 97.00% | 97.00% | 97.00% | 97.00% | 97.00% |
| Max. efficiency | 97.80% | 97.80% | 97.80% | 97.80% | 97.80% | 97.80% |
| Max. battery charge efficiency (PV to BAT) (@full load) | 98.50% | 98.50% | 98.50% | 98.50% | 98.50% | 98.50% |
| Max. battery discharge efficiency (BAT to AC) (@full load) | 97.00% | 97.00% | 97.00% | 97.00% | 97.00% | 97.00% |
| Standby consumption [W] (Idle) | <3 | | | | | |
| STANDARD | | | | | | |
| Safety | IEC62109-1 /-2 / IEC62040/ IEC62477 | | | | | |
| EMC | EN 61000-6-1 / EN 61000-6-2 / EN 61000-6-3 | | | | | |
| Certification | G98 / G99 / AS4777.2 / EN50549-1 / CEI 0-21 / VDE-AR-N 4105 / NRS097-2-1 and so on | | | | | |

4.5 Battery

| | | | |
|-----------------------------------|------------------------|------------------------|------------------------|
| Model | AIO-AC1-3.0 | AIO-AC1-3.0 | AIO-AC1-3.0 |
| | AIO-H1-3.0 | AIO-H1-3.0 | AIO-H1-3.0 |
| | AIO-AC1-3.7 | AIO-AC1-3.7 | AIO-AC1-3.7 |
| | AIO-H1-3.7 AIO-AC1-4.6 | AIO-H1-3.7 AIO-AC1-4.6 | AIO-H1-3.7 AIO-AC1-4.6 |
| | AIO-H1-4.6 | AIO-H1-4.6 | AIO-H1-4.6 |
| | AIO-AC1-5.0 | AIO-AC1-5.0 | AIO-AC1-5.0 |
| | AIO-H1-5.0 | AIO-H1-5.0 | AIO-H1-5.0 |
| | AIO-AC1-6.0 | AIO-AC1-6.0 | AIO-AC1-6.0 |
| | AIO-H1-6.0 | AIO-H1-6.0 | AIO-H1-6.0 |
| | AIO-AC1-5.0-HVS5.2 | AIO-AC1-5.0-HVS7.8 | AC1-5.0-HVS10.4 |
| | AIO-AC1-6.0-HVS5.2 | AIO-AC1-6.0-HVS7.8 | AIO-AC1-6.0-HVS10.4 |
| | AIO-H1-5.0-HVS5.2 | AIO-H1-5.0-HVS7.8 | AIO-H1-5.0-HVS10.4 |
| AIO-H1-6.0-HVS5.2 | AIO-H1-6.0-HVS7.8 | AIO-H1-6.0-HVS10.4 | |
| Battery capacity (kWh) | 5.2 | 7.8 | 10.4 |
| Battery voltage range (V) | 85-116.8 | 120-175.2 | 160-233.6 |
| Max. discharge/charge current (A) | 40/40 | | |
| Battery type | Lithium-Ion | | |

4.6 General Data

| DIMENSION AND WEIGHT | |
|----------------------------------|--|
| Dimensions (WxHxD) [mm] | 624*1662*375 |
| Weight [kg] | 78 (Exclude batteries) |
| Cooling concept | Nature |
| Topology | Non-Isolated |
| Communication | Ethernet, Meter, WiFi/GPRS/LAN, DRM, USB, CT |
| LCD display | Backlight 16*4 character |
| ENVIRONMENT LIMIT | |
| Ingress protection | IP65 |
| Protective Class | Class I |
| Operating temperature range [°C] | -25..... +60°C (derating at +45°C) |
| Humidity [%] | 0~100 (non-condensing) |
| Altitude [m] | <2000 |
| Storage temperature [°C] | -40..... +70°C |
| Noise emission(typical) [dB] | <40 |
| Over voltage category | III(AC), II(DC) |

5. Installation

5.1 Check for Physical Damage

Make sure the energy station is intact during transportation. If there is any visible damage, such as cracks, please contact your dealer immediately.

5.2 Packing List

Open the package and take out the product, please check the accessories first. The packing list shown as below.

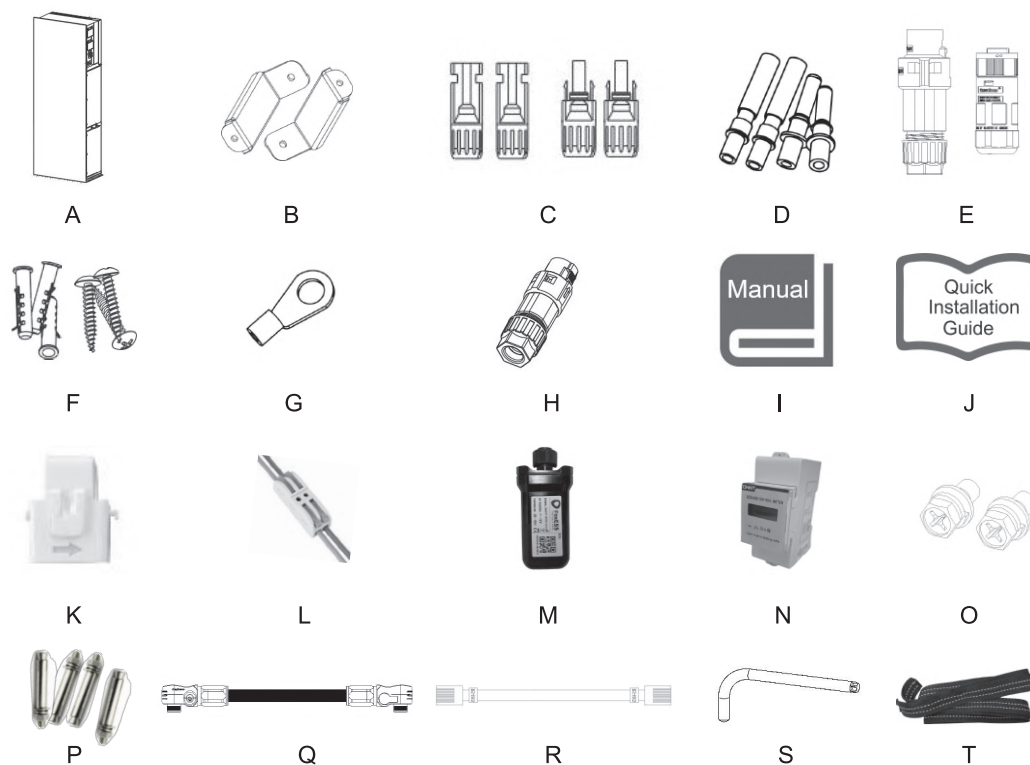

| Object | Quantity | Description | Object | Quantity | Description |
|--------|----------|---|--------|----------|---|
| A | 1 | Energy station | K | 1 | CT (with 10m cable) |
| B | 2 | Brackets | L | 1 | CT extension connector |
| C | 4 | PV connectors (Only for AIO-H1) (2*positive, 2*negative) | M | 1 | WiFi/LAN/GPRS (Optional) |
| D | 4 | PV pin contacts (Only for AIO-H1) (2*positive, 2*negative) | N | 1 | Meter (Optional) |
| E | 2 | AC connectors | O | 2 | Hexagonal screws |
| F | 3 | Expansion tubes & Expansion screws | P | 4 | Expansion screws (For ground installation) |
| G | 1 | Earth terminal | Q | 3 | Battery Power cables (1*320mm, 1*620mm, 1*900mm) |
| H | 1 | Communication connector | R | 1 | Communication cable |
| I | 1 | Product manual | S | 1 | Offset ring spanner |
| J | 1 | Quick installation guide | T | 1 | Binding band |

5.3 Mounting

- Installation Precaution

Make sure the installation site meets the following conditions:

- Not in direct sunlight.
- Not in areas where highly flammable materials are stored.
- Not in potential explosive areas.
- Not in the cool air directly.
- Not near the television antenna or antenna cable.
- Not higher than altitude of about 2000m above sea level.
- Not in environment of precipitation or humidity (> 95%).
- Under good ventilation condition.
- The ambient temperature in the range of -25°C to +60°C.
- The slope of the wall should be within +5*.
- The wall hanging the energy station should meet conditions below:
 - Solid brick/concrete, or strength equivalent mounting surface;
 - Energy station must be supported or strengthened if the wall's strength isn't enough (such as wooden wall, the wall covered by thick layer of decoration).

Please avoid direct sunlight, rain exposure, snow laying up during installation and operation.

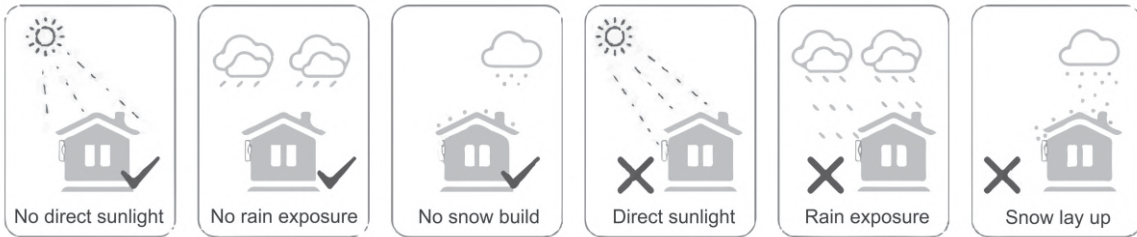

- Space Requirement

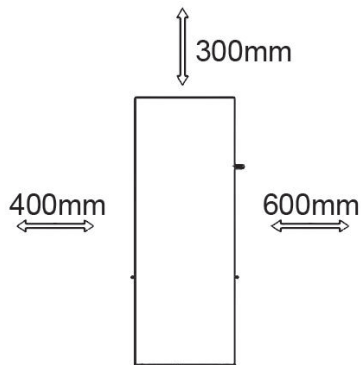

| Position | Min Distance |
|----------|--------------|
| Left | 400mm |
| Right | 600mm |
| Top | 300mm |

- Mounting Steps

Tools required for installation:

- Manual wrench;
- Electric drill (drill bit set 8mm);
- Crimping pliers;
- Stripping pliers;
- Screwdriver.



1. AIO series energy station installation

A. Wall mounting

- Choose a clean and stable wall surface for installation.
- Use hexagonal screws to fix the brackets on the back of the All-In-One.
- Aim the All-In-One towards the wall and mark position of two holes from brackets.

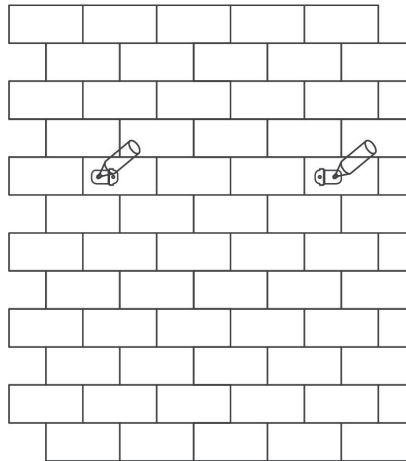
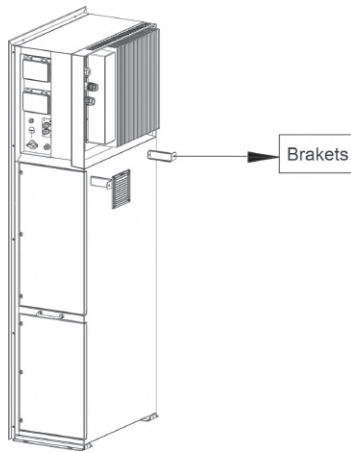

- Drill holes on the marks with a diameter of 6mm drill. Insert the expansion screws into the hole.

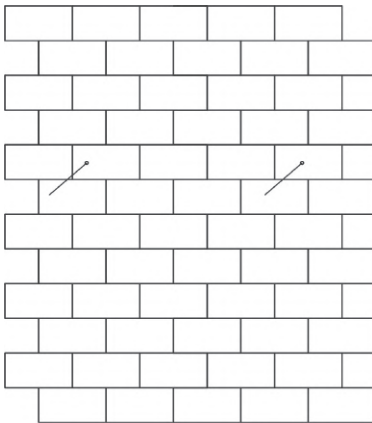

- Align the All-In-One with expansion screws and tighten the screws firmly.

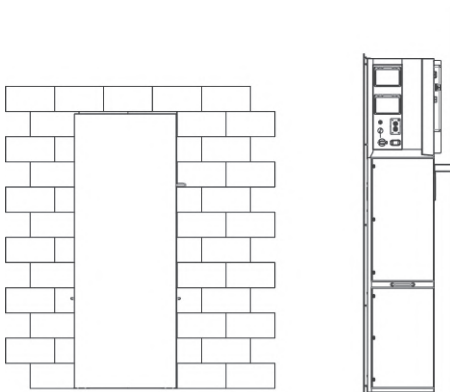

B. Ground installation

- Choose a flat and stable ground for installation and place the All-In-One on that ground.
- Mark position of the four corners on the bottom of the All-In-One then remove the All-In-One.
- Drill holes on the marks, make sure the depth is at least 60mm, the diameter of the holes is about 13-14 mm. The hole which closest to the wall should keep a minimum distance of 170mm from the wall.

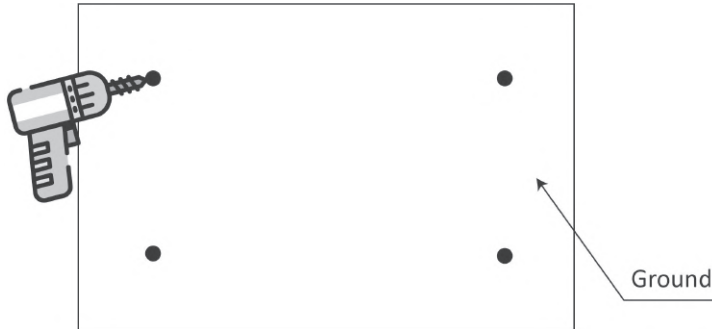

- Insert the expansion screw into the ground.
- Place the All-In-One back to the ground, align the All-In-One with four expansion screws and tighten the screws firmly.

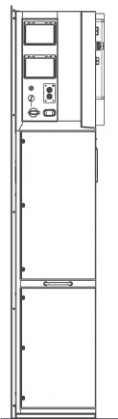

Note: For easy installation, instead of using the All-In-One for hole remarks, you can remark the hole with the installation guide (Size is same as All-In-One).

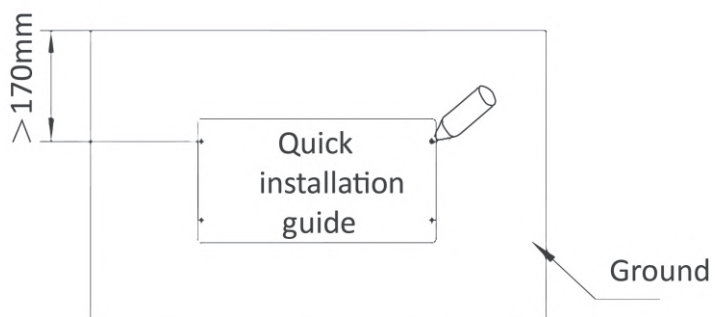

2. Battery installation

- Remove the bracket on both sides of the battery. There are eight screws on the left and right sides (4*left, 4*right).

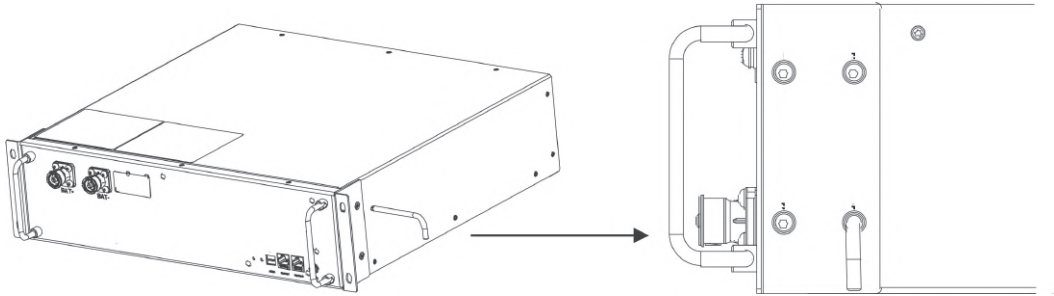

- Push the battery into the All-In-One as shown in the figure below.

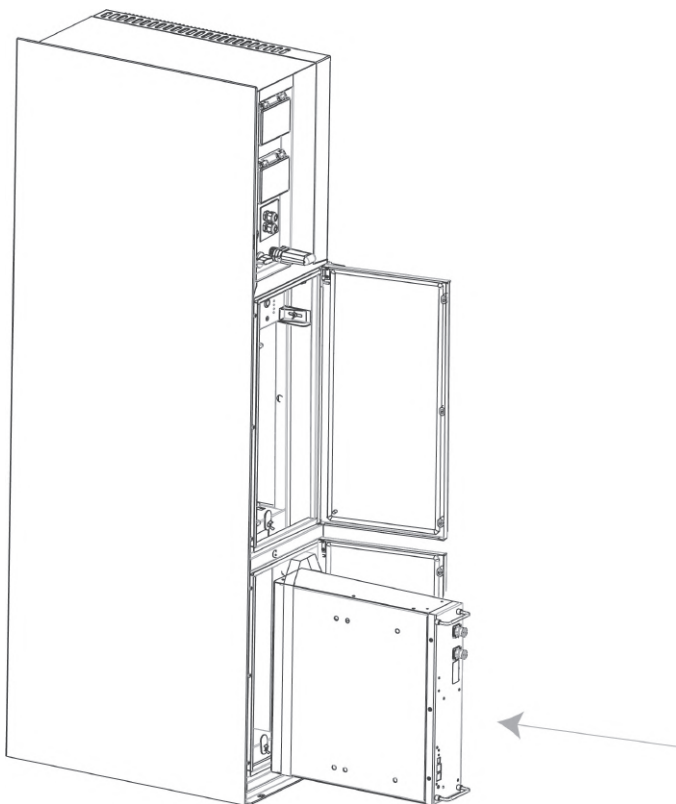

6. Electrical Connection

The following figure is a detailed electrical connection system diagram of the AIO series, which can be used for installation reference.

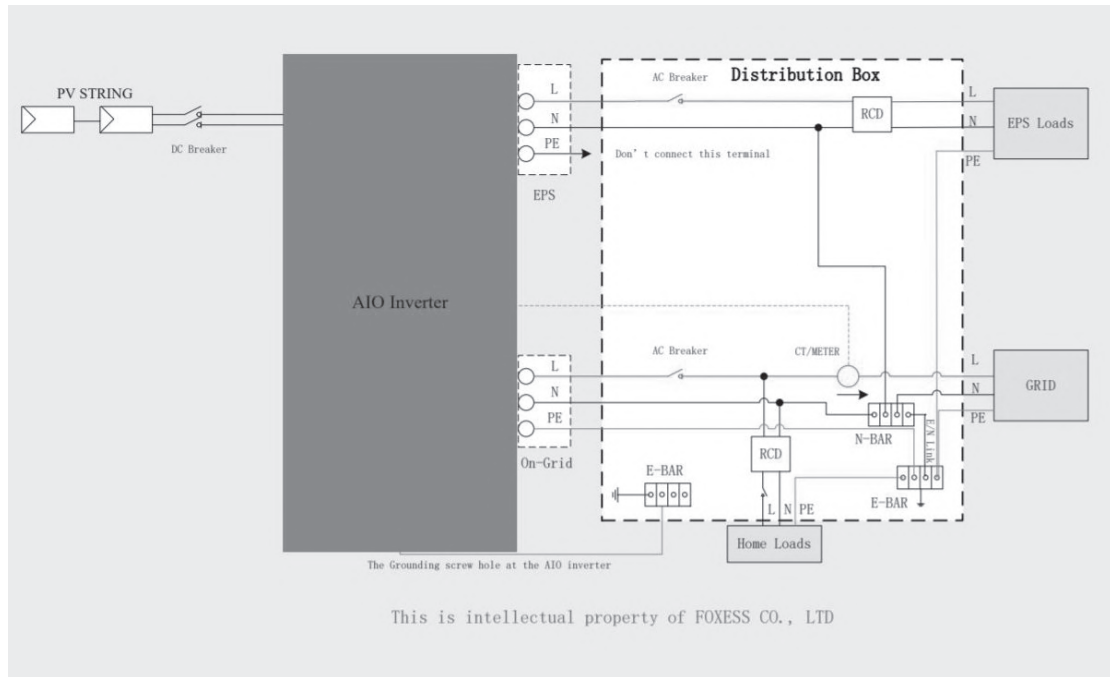





The installer must comply with local wiring regulations and rules, the diagram is for reference only.

6.1 PV Connection (For AIO-H1 Only)

Step 1: PV String Connection

AIO-H1 series energy stations can be connected with 2-strings of PV modules. Please select suitable PV modules with high reliability and quality. Open circuit voltage of module array connected should be less than 600V, and operating voltage should be within the MPPT voltage range.

| | |
|---|---|
|  | <p>Note!</p> <p>Please choose a suitable external DC switch if the energy station does not have a built-in DC switch.</p> |
|  | <p>Warning!</p> <p>PV module voltage is very high and within a dangerous voltage range, please comply with the electric safety rules when connecting.</p> |
|  | <p>Warning!</p> <p>Please do not make PV positive or negative to ground!</p> |
|  | <p>Note!</p> <p>PV modules: Please ensure they are the same type, have the same output and specifications, are aligned identically, and are tilted to the same angle. In order to save cable and reduce DC loss, we recommend installing the energy station as near to the PV modules as possible.</p> |

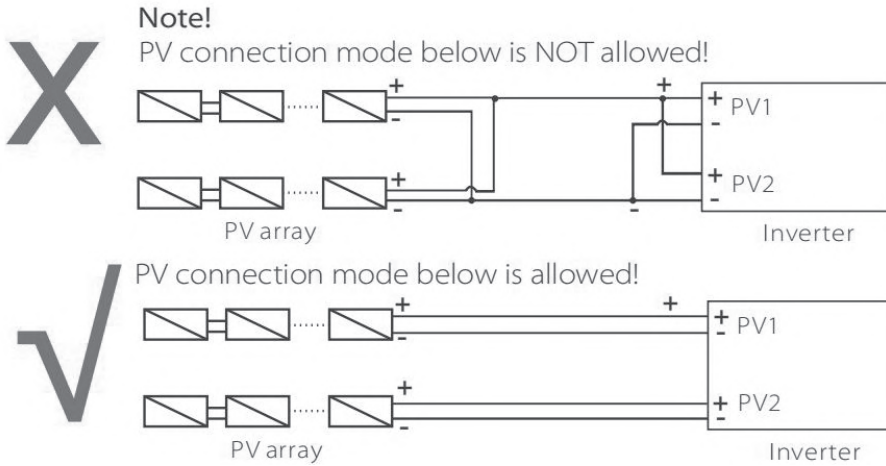

Step 2: PV Wiring

- Turn off the DC switch.
- Choose 12 AWG wire to connect the PV module.
- Trim 6mm of insulation from the wire end.

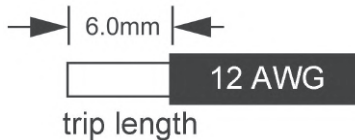

- Separate the DC connector (PV) as below.

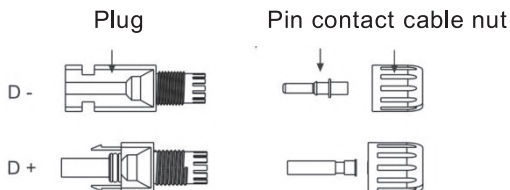

- Insert striped cable into pin contact and ensure all conductor strands are captured in the pin contact.
- Crimp pin contact by using a crimping plier. Put the pin contact with striped cable into the corresponding crimping pliers and crimp the contact.

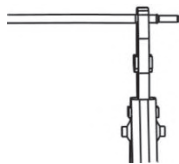

- Insert pin contact through the cable nut to assemble into back of the male or female plug. When you feel or hear a “click” the pin contact assembly is seated correctly.



- Unlock the DC connector
 - Use the specified wrench tool.
 - When separating the DC + connector, push the tool down from the top.
 - When separating the DC - connector, push the tool down from the bottom.
 - Separate the connectors by hand.

6.2 Battery Connection

A. Connection of battery power cable and communication cable

- For two batteries

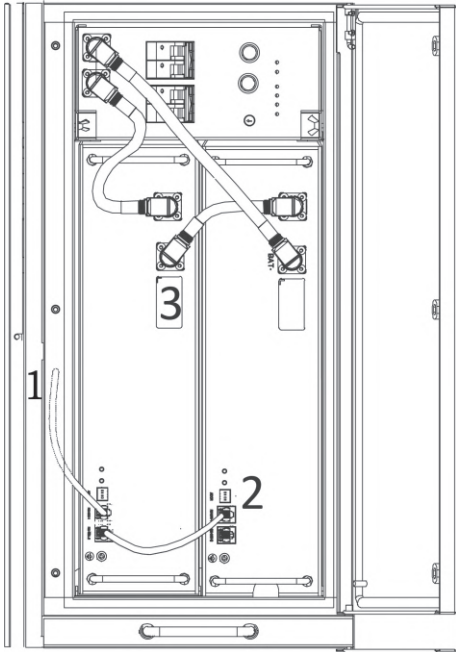

Note:

No.1 is reserved cable.

No.2 & No.3 please find it in the battery pack.

- For three batteries

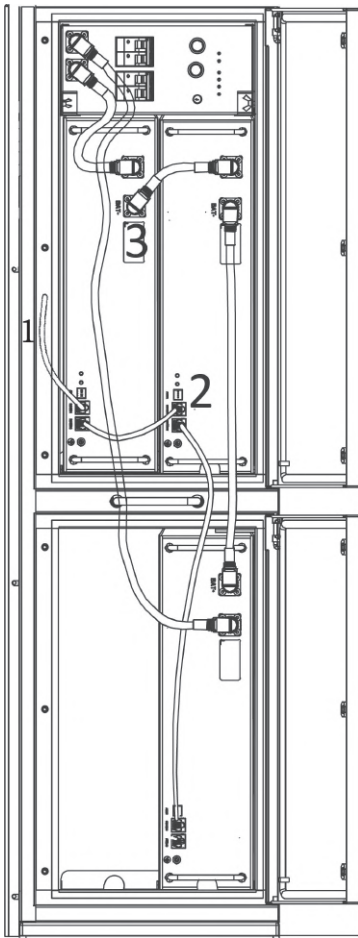

Note:

No.1 is reserved cable.

No.2 & No.3 please find it in the battery pack.

- For four batteries

Note:

No.1 is reserved cable.

No.2 & No.3 & No.4 & No.5 please find it in the battery pack.

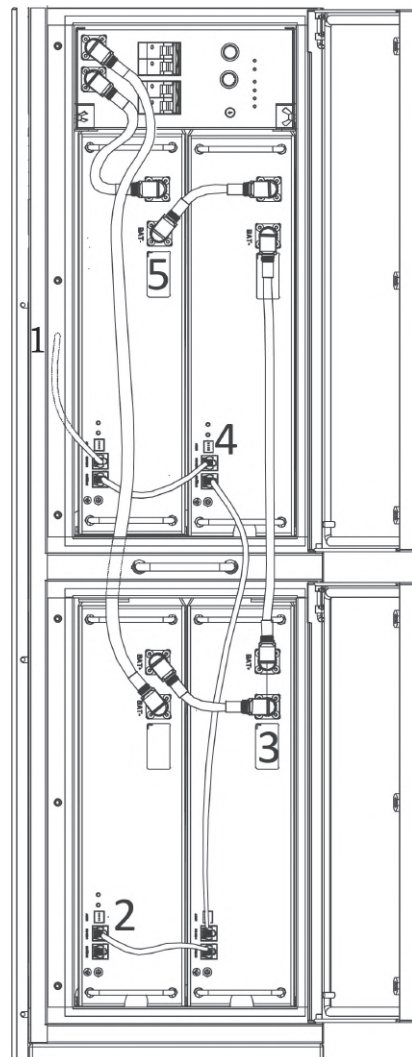

B. Connection of battery ground cable

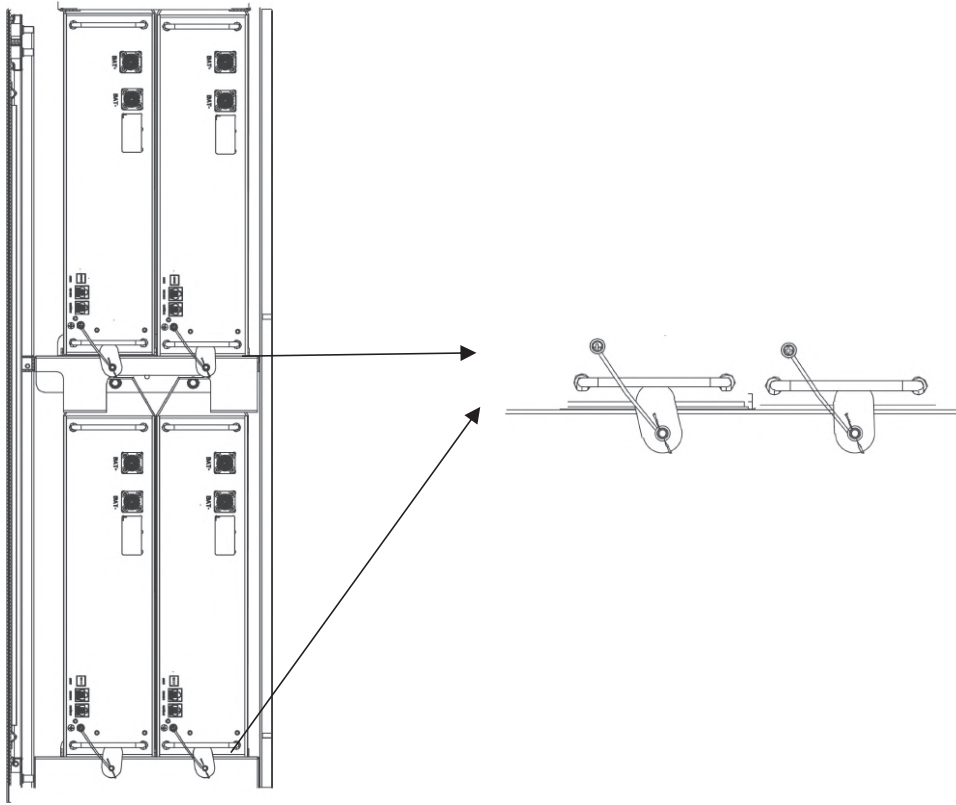

Note: Four ground cables please find it in the battery pack.

6.3 Grid Connection

Step 1: Grid String Connection

AIO series energy stations are designed for single-phase grid. Voltage range is 220/230/240V; frequency is 50/60Hz. Other technical requests should comply with the requirement of the local public grid.

| Model (kW) | 3.0 | 3.7 | 4.6 | 5.0 | 6.0 |
|-----------------|--------------------|--------------------|--------------------|--------------------|---------------------|
| Cable (ON-GRID) | 8.0mm ² | 8.0mm ² | 8.0mm ² | 8.0mm ² | 10.0mm ² |
| Cable (EPS) | 4.0mm ² | 4.0mm ² | 6.0mm ² | 6.0mm ² | 6.0mm ² |
| Micro-Breaker | 50A | 50A | 63A | 63A | 63A |

Note: If you don't use the BACK-UP function or use ON-GRID power to charge the battery, the wiring conduct core section can use 4-6mm².

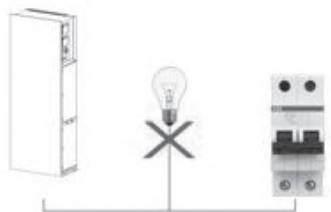



WARNING!

A micro-breaker for max output overcurrent protection device shall be installed between energy station and grid, and the current of the protection device is referred to the table above, any load SHOULD NOT be connected with the energy station directly.

Step 2: Grid Wiring

- Check the grid voltage and compare with the permitted voltage range (refer to technical data).
- Disconnect the circuit-breaker from all the phases and secure against re-connection.
- Trim the wires:
 - Trim all the wires to 52.5mm and the PE wire to 55mm.
 - Use the crimping pliers to trim 12mm of insulation from all wire ends as below.

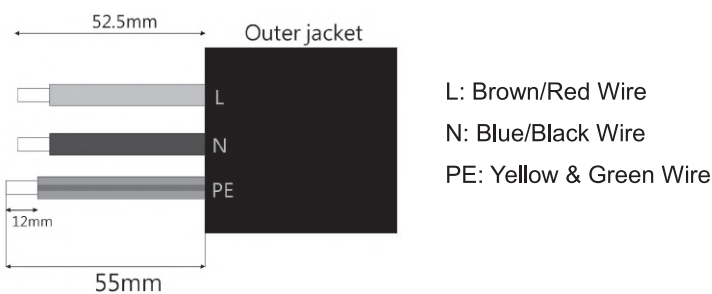

Note: Please refer to local cable type and color for actual installation.

A. EPS Wiring

- Run the cable into the sleeve assembly.

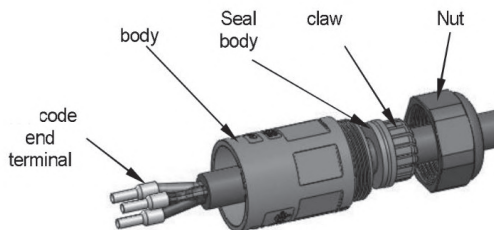

- Install the cable into the plug terminal and lock the screw, torque is (0.8 + / - 0.1 N·m).



- Insert the plastic core into the main body.

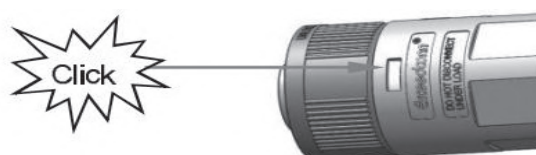

- Put the sealing body and yarn trapper into the main body, screw the lock nut into the main body, and the torque is $(2.5 \pm 0.5N \cdot m)$.

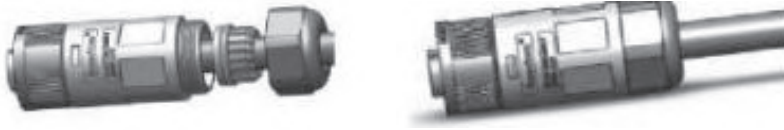

- Insert the male end into the female end. For the rotation direction of the lock, please refer to the LOCK mark on the assembly.

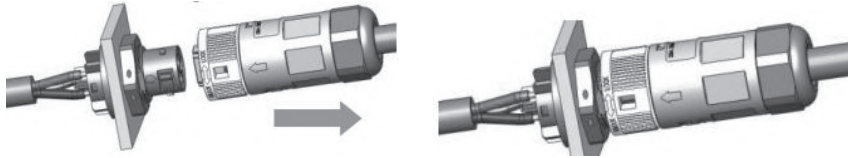

B. ON-GRID Wiring

- Separate the ON-GRID plug into three parts as below.
 - Hold middle part of the female insert, rotate the back shell to loosen it, detach it from female inset.
 - Remove the cable nut (with rubber insert) from the back shell.

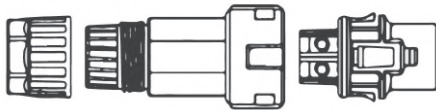

- Slide the cable nut and then the back shell onto the cable.

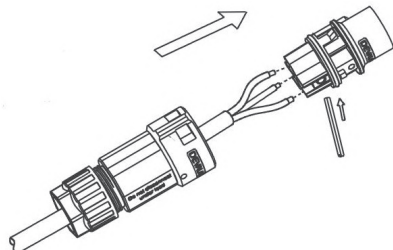

- Push the threaded sleeve into the socket, tighten up the cap on the terminal.

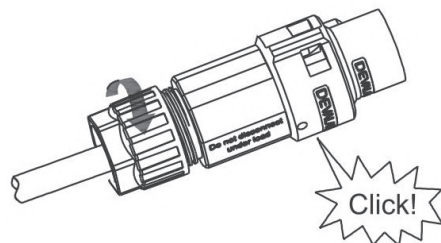

- Push the threaded sleeve to connection terminal until both are locked tightly on the energy station.

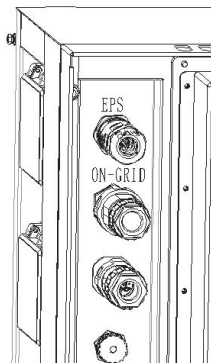

- Remove the ON-GRID connector: Press the bayonet out of the slot with a small screwdriver or the unlock tool and pull it out, or unscrew the threaded sleeve, then pull it out.

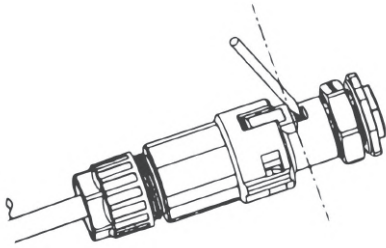

6.4 Earth Connection

Screw the ground screw with screwdriver as shown below:

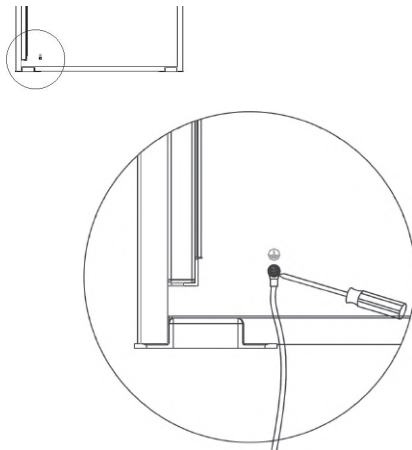

a) Permanently connected wiring, and:

- a cross-section of the protective earthing conductor of at least 10 mm² if copper, or 16 mm² if aluminum;
- or
- automatic disconnection of the supply in case of discontinuity of the protective earthing conductor;
- or
- provision of an additional terminal for a second protective earthing conductor of the same cross-sectional area as the original protective earthing conductor and installation instructions requiring a second protective earthing conductor to be installed.

6.5 Communication Device Installation (Optional)

AIO series energy stations are available with multiple communication options such as WiFi, LAN, GPRS, RS485 and Meter with an external device.

Operating information like output voltage, current, frequency, fault information, etc., can be monitored locally or remotely via these interfaces.

- **WiFi/LAN/GPRS (Optional)**

The energy station has an interface for WiFi/LAN/GPRS devices that allow this device to collect information from energy station; including energy station working status, performance etc., and update that information to monitoring platform (the WiFi/LAN/GPRS device is available to purchase from your local supplier).

Connection steps:

1. For GPRS device: Please insert the SIM Card (please refer to the GPRS product manual for more details).
2. For LAN device: Please complete the wiring between router and LAN device (please refer to the LAN product manual for more details).
3. Plug the WiFi/LAN/GPRS device into “WiFi/GPRS” port at the bottom of the energy station.
4. For WiFi device: Connect the WiFi with the local router, and complete the WiFi configuration (please refer to the WiFi product manual for more details).
5. Set-up the site account on the Fox monitoring platform (please refer to the monitoring user manual for more details).

• **Meter (optional)/CT/RS485**

The energy station has integrated export limitation functionality. To use this function, a power meter or a CT must be installed. The PIN definitions of Meter/CT/485 interface are as below.

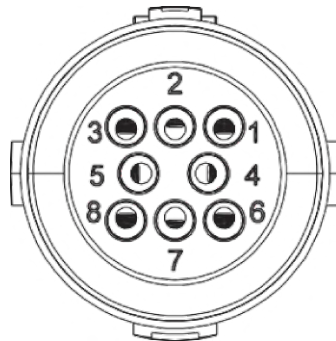

| PIN | 1 | 2 | 3 | 4 | 5 | 6 | 7 | 8 |
|------------|-----------|-----------|------|------|------|------|------|------|
| Definition | Meter485A | Meter485B | 485B | 485A | CT2+ | CT2- | CT1- | CT1+ |

Note:

- CT1: For AIO.
CT2: Grid tied inverter (if have).
- Compatible Meter type: DDSU666 (CHINT), SDM230 (EASTRON).

- CT

This energy station has an integrated export management function. To enable this function, a power meter or CT must be installed. The CT should be clamped on the main live line of the grid side. The arrow on the CT should be pointing towards the grid. The white cable connects to CT+, and the black cable connects to CT-.

Meter/CT setting:

Short press the touch key to switch display or make the number+1. Long press the touch key to confirm your setting.

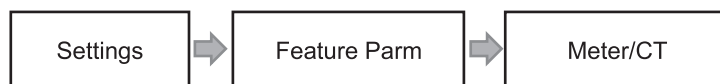

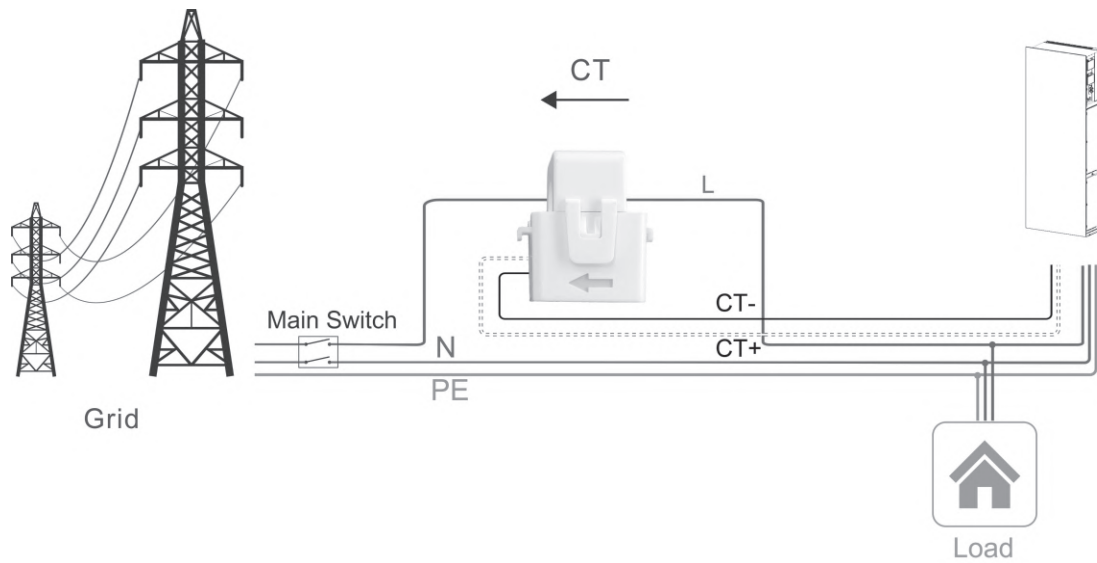

If there is another generator in the home, CT2 can be used to record the power generated by the generator and transmit the data to the website for monitoring.

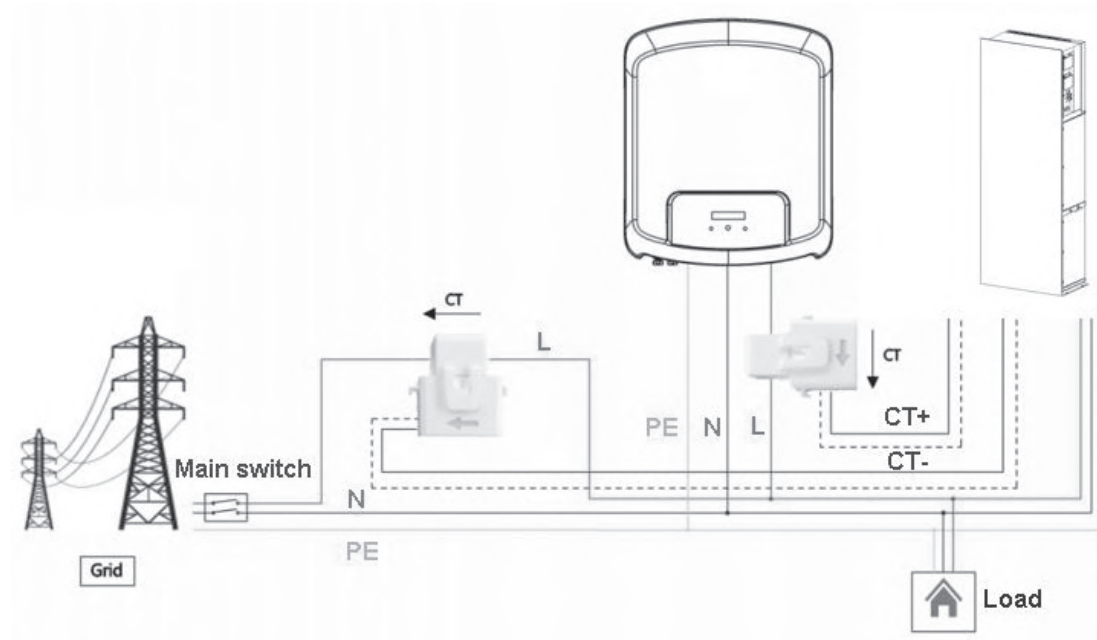

Note! For a precise reading and control of power, a meter can be used instead of a CT. If the CT is fitted in the wrong orientation, anti-backflow function will fail.

- RS485

RS485 is a standard communication interface which can transmit the real time data from energy station to PC or other monitoring devices.

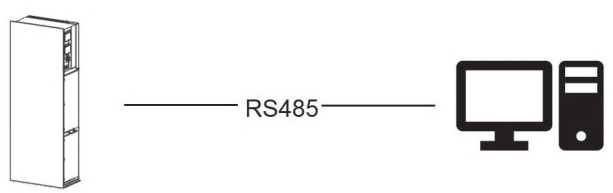

- Meter (optional)

The energy station has integrated export limitation functionality. To use this function, a power meter or a CT must be installed. For Meter installation, please install it on the grid side.

Export limitation setting:

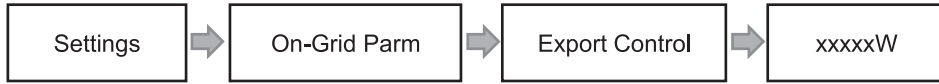

The electricity meter is connected as follows:

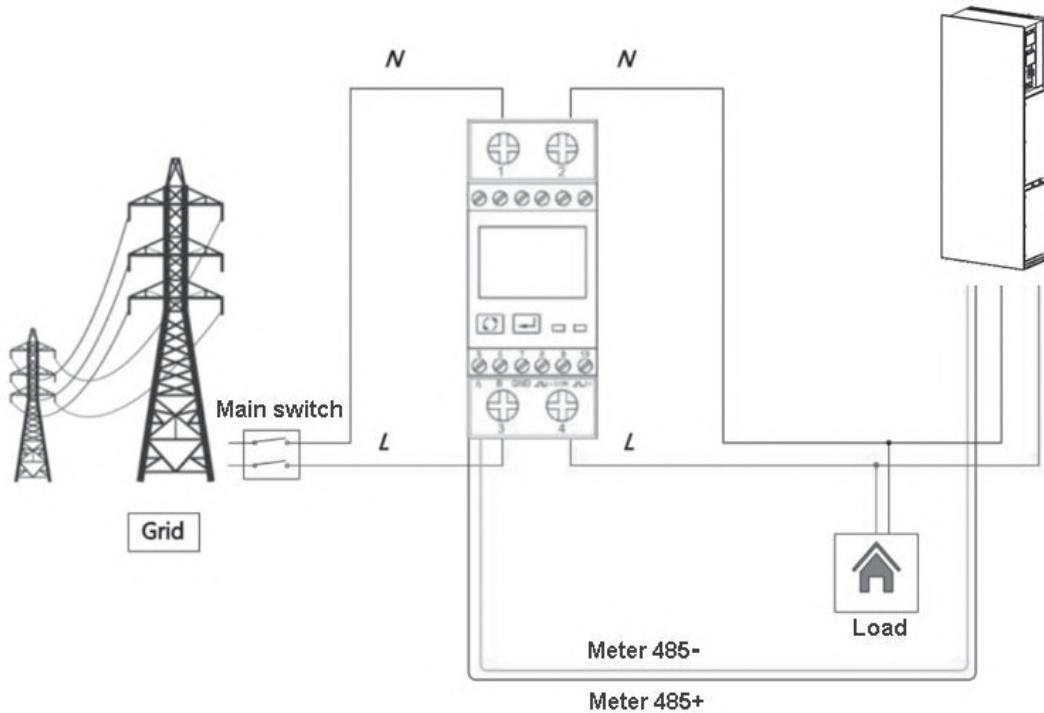

- **DRM**

DRM0 setting

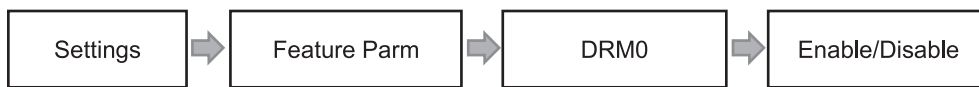

DRM is provided to support several demand response modes by emitting control signals as below.

| Mode | Requirement |
|------|--|
| DRM0 | Operate the disconnection device. |
| DRM1 | Do not consume power. |
| DRM2 | Do not consume at more than 50% of rated power. |
| DRM3 | Do not consume at more than 75% of rated power and source reactive power if capable. |
| DRM4 | Increase power consumption (subject to constraints from other active DRMs). |
| DRM5 | Do not generate power. |
| DRM6 | Do not generate at more than 50% of rated power. |
| DRM7 | Do not generate at more than 75% of rated power and sink reactive power if capable. |
| DRM8 | Increase power generation (subject to constraints from other active DRMs). |

DRM PIN Definition

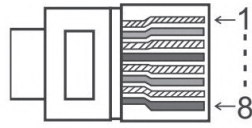

| PIN | 1 | 2 | 3 | 4 | 5 | 6 | 7 | 8 |
|------------|-----|-----|------|-------|--------|--------|--------|--------|
| Definition | GND | GND | DRM0 | +3.3V | DRM4/8 | DRM3/7 | DRM2/6 | DRM1/5 |

| Model | Socket asserted by shorting pins | | Function |
|-------|----------------------------------|---|-----------------------------------|
| DRM0 | 3 | 4 | Operate the disconnection device. |

• Ethernet

Ethernet communication is the standard communication interface.

Application Occasion

This function is applicable for the below situation:

For data transmission: It can transmit the energy station data from energy station to PC or other monitoring equipment.

Ethernet PIN Definition

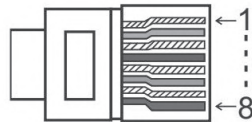

| PIN | 1 | 2 | 3 | 4 | 5 | 6 | 7 | 8 |
|------------|-----|-----|-----|---|---|-----|---|---|
| Definition | TX+ | TX- | RX+ | X | X | RX- | X | X |

• COM

ESTOP: Close the energy station.

Generator: Connect the generator and start-up it.

CAN: External debug.

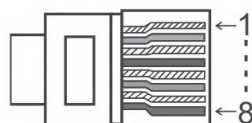

| PIN | 1 | 2 | 3 | 4 | 5 | 6 | 7 | 8 |
|------------|--------|-----|-----------|----------|----------|-------|-----|-------|
| Definition | +3.3 V | GND | GENERATOR | BMS-CANL | BMS-CANH | +3.3V | GND | ESTOP |

| Model | Socket asserted by shorting pins | | Function |
|-------|----------------------------------|---|------------------------------------|
| ESTOP | 7 | 8 | Emergency stop the energy station. |

Connection steps:

Step 1: Open the lid cover.

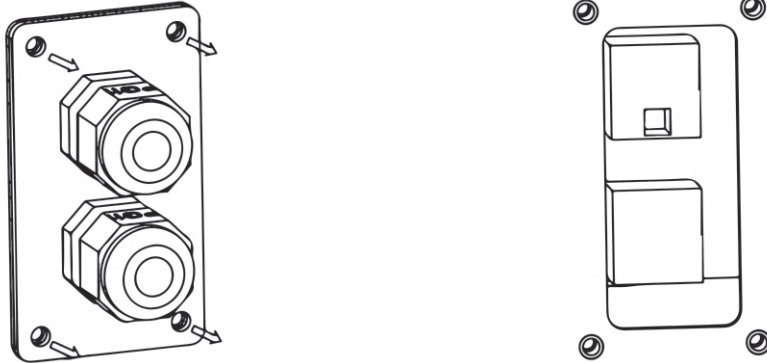

Step 2: Prepare a standard network cable and cable connector, then insert the network cable through the cable connector.

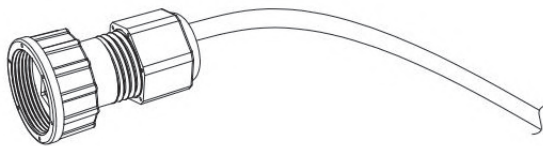

Step 3: Crimp the cable with a Rj45 plug which is inside of the cable connector.

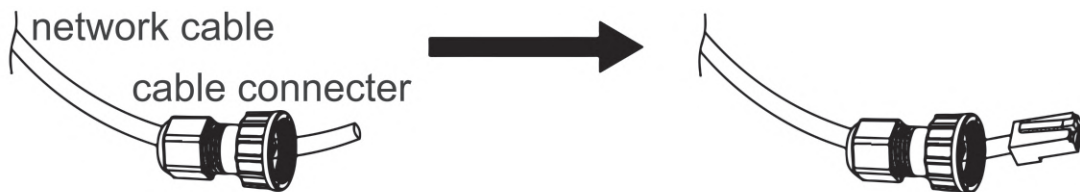

Rj45 plug 

Step 4: Insert the cable connector into COM port at the bottom of energy station and screw it tightly. Then insert other side of the network cable into PC or other device.

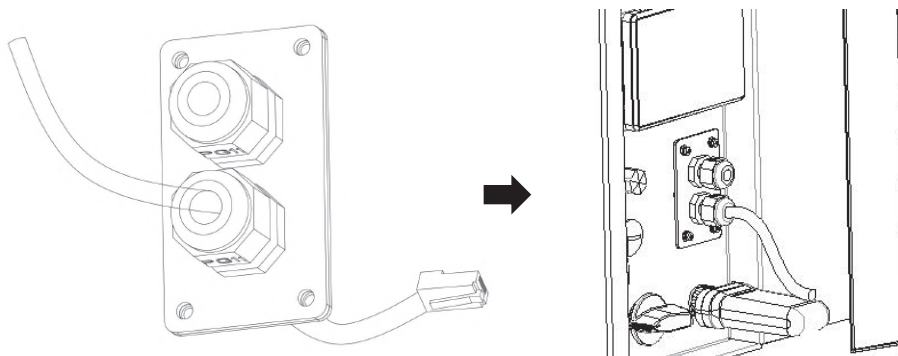

Note:

- Isolation Fault (Australia Market Only)

This energy station complies with IEC 62109-2 clause 13.9 for earth fault alarm monitoring. If an Earth Fault Alarm occurs, the fault code Isolation fault will be displayed on the energy station screen and the RED LED indicator will light up.

- Reactive Power Regulation for Voltage Variation (Volt-VAr Mode)

Details of how to enable this mode are contained in the “Advanced Configuration Guide”, which can be accessed at our website at <https://www.foxess.com>.

- Power Derating for Voltage Variation (Volt-Watt Mode)

Details of how to enable this mode are contained in the “Advanced Configuration Guide”, which can be accessed at our website at <https://www.foxess.com>.

6.6 EPS Connection

A. EPS Wiring

EPS mode can be achieved by two different type of wiring methods. One is using the internal bypass to wire the house emergency loads on the EPS port from inverter. Another is using external contactor to wire the EPS loads on the contactor self (External contactor need to be purchased separately).

Note: the inverter default is set as “External” EPS wiring mode, it can be set to “Internal” via display setting “Menu – Setting – Feature – Bypass Relay”.

- Use Internal EPS Wiring:

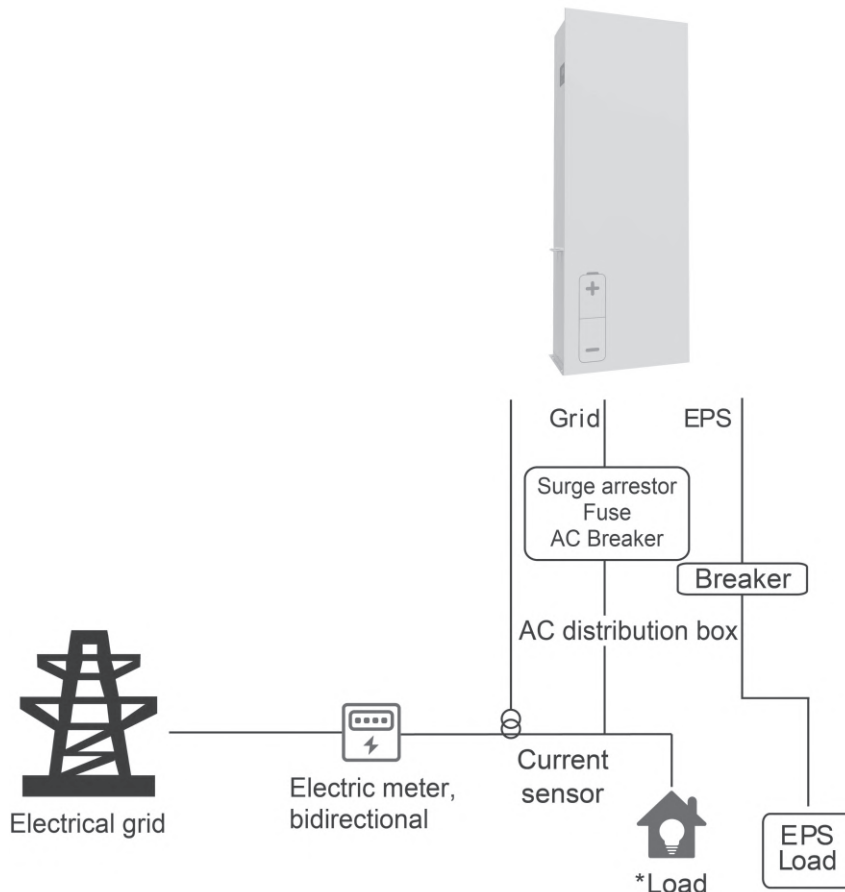

Notes:

1. Under On-grid mode, please ensure that the EPS loads power is lower than the inverter's maximum Bypass power.
2. Under Off-grid mode, ensure that the EPS loads power is lower than the inverter's maximum EPS power.
3. We suggest not connect the inductive loads on EPS port.

- **Use External EPS Wiring:**

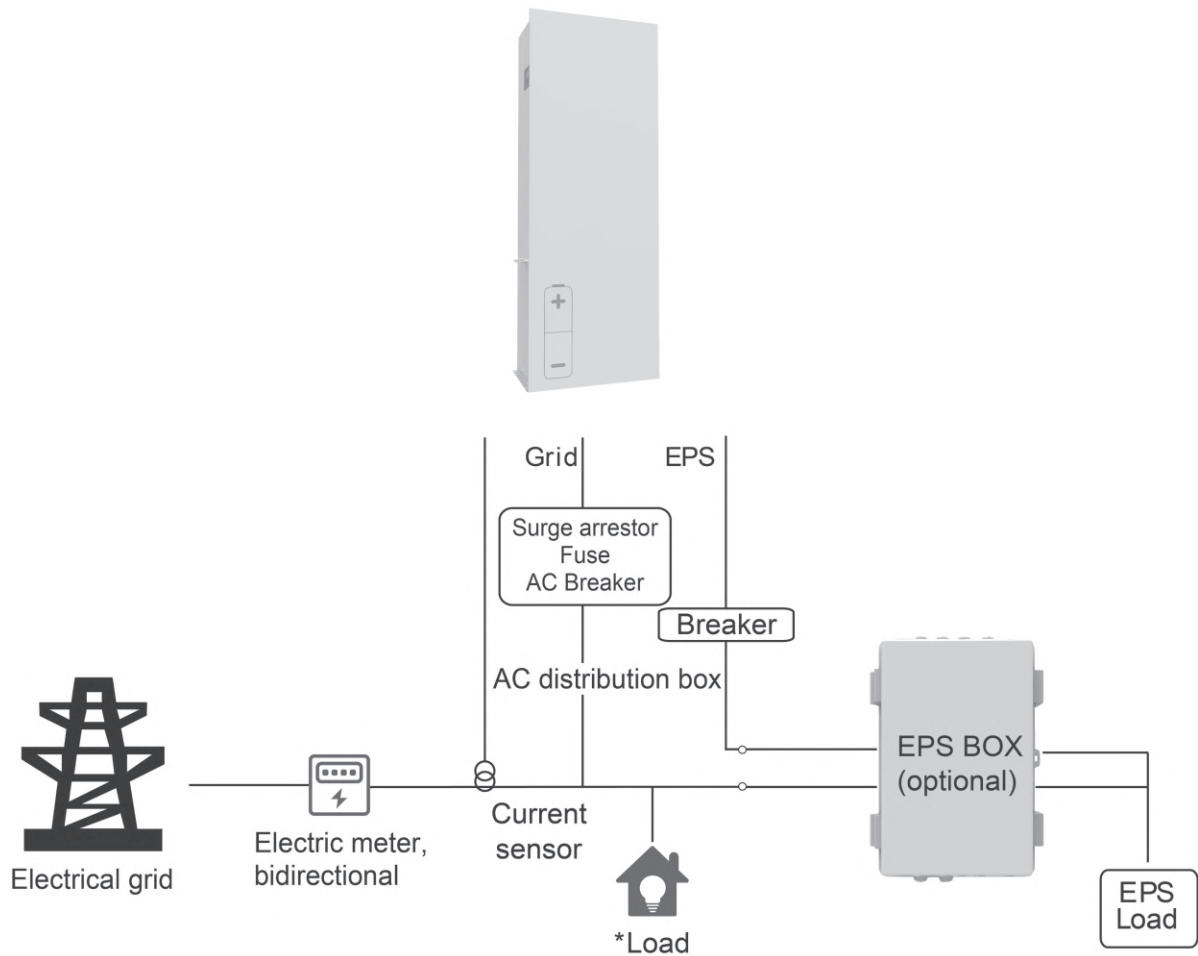







Notes:

1. EPS Box (Optional): Used for On-Grid and EPS switching of inverters, improve maximum EPS loads capacity, maximum bypass current is 60A.
2. When the grid power is off, ensure that the Back-up load power is lower than the inverter's maximum output power.

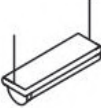
B. Common loads description

Under EPS mode, if need to connect the inductive load on EPS port, please ensure that the instantaneous power of the load at startup is lower than the maximum power of the EPS mode. Below table shows some conventional and reasonable loads for you reference. Please refer to your loads' manual for the actual specs.

| Type | Power | | Common equipment | Example | | |
|-----------------|-------|-------|---|---|---------------|-----------|
| | Start | Rated | | Equipment | Start | Rated |
| Resistive load | X 1 | X 1 |   Incandescent lamp TV |  100W Incandescent lamp | 100VA (W) | 100VA (W) |
| Capacitive load | X 2 | X 1.5 |  Fluorescent lamp |  40W Fluorescent lamp | 80VA (W) | 60VA (W) |
| Inductive load | X 3~5 | X 2 |   Fan Fridge |  150W Fridge | 450-750VA (W) | 300VA (W) |

6.7 Energy Station Start-Up

Please refer to the following steps to start up the energy station.

1. Ensure the energy station fixed well.
2. Make sure all the DC wirings and AC wirings are completed.
3. Make sure the CT/meter is connected well.
4. Make sure the battery is connected well.
5. Make sure the external EPS contactor is connected well (if needed).
6. Turn on the PV/DC switch (for AIO-H1 only), AC breaker, EPS breaker and battery breaker.
7. Enter the settings page, default password is '000000', select START / STOP and set it to start.

Note:

- When starting the energy station for the first time, the country code will be set by default to the local settings. Please check if the country code is correct.
- Set the time on the energy station using the button or by using the APP.
- The internal bypass relay is closed by default, if it needs to be opened, enter the setting page, select "Internal".
- EPS function is off by default, if it needs to be opened, enter the setting page, select EPS "ON/OFF", default eps voltage/frequency is 230V and 50Hz.

6.8 Energy Station Switch Off

Please refer to the following steps to switch off the energy station.

1. Enter the settings page, select START / STOP and set it to stop.
2. Turn off the PV/DC switch (for AIO-H1 only), AC breaker, EPS breaker and battery breaker.
3. Wait 5 min before you open the upper lid (if in need of repair).

7. Firmware Upgrading

User can upgrade energy station's firmware via a U-disk.

- Safety check

Please ensure the energy station is steadily powered on.

energy station must keep the battery on through whole procedure of upgrading. Please prepare a PC and make sure the size of U-disk is under 32G, and the format is fat 16 or fat 32.

- Upgrading steps:

Step 1: Please contact our service support to get the update files, and extract it into your U-disk as follow:

update/master/ H1_master_vx.xx.bin

update/slave/ H1_slave_vx.xx.bin

update/manager/ H1_manager_vx.xx.bin

Note: vx.xx is version number.

Warning: Make sure the directory is in accordance with above form strictly! Do not modify the program file name, or it may cause the energy station not work anymore!

Step 2: Unscrew the waterproof lid and insert U-disk into the "USB" port at the bottom of the energy station.

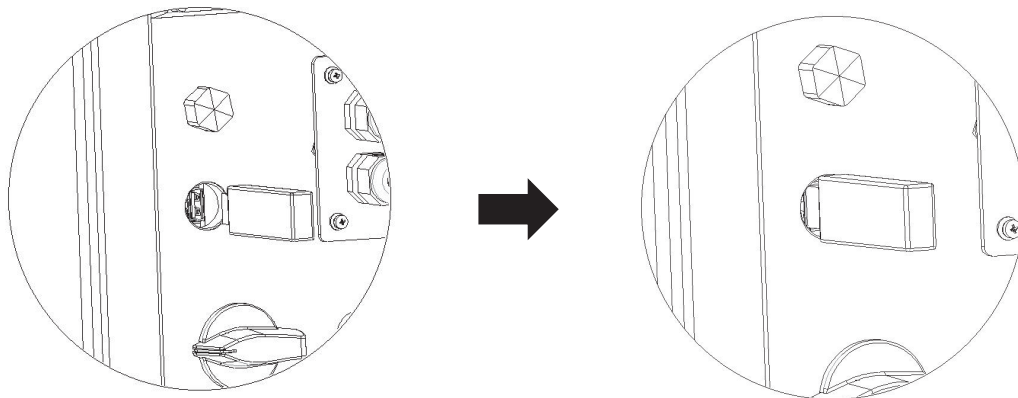

Step 3: The LCD will show the selection menu. Then press up and down to select the one that you want to upgrade and press "OK" to confirm to upgrade.

Step 4: After the upgrade is finished, pull out the U-disk. Screw the waterproof lid.

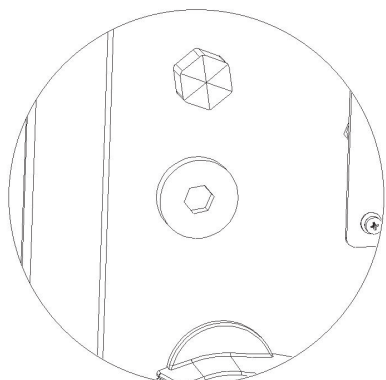

8. Operation

8.1 Control Panel

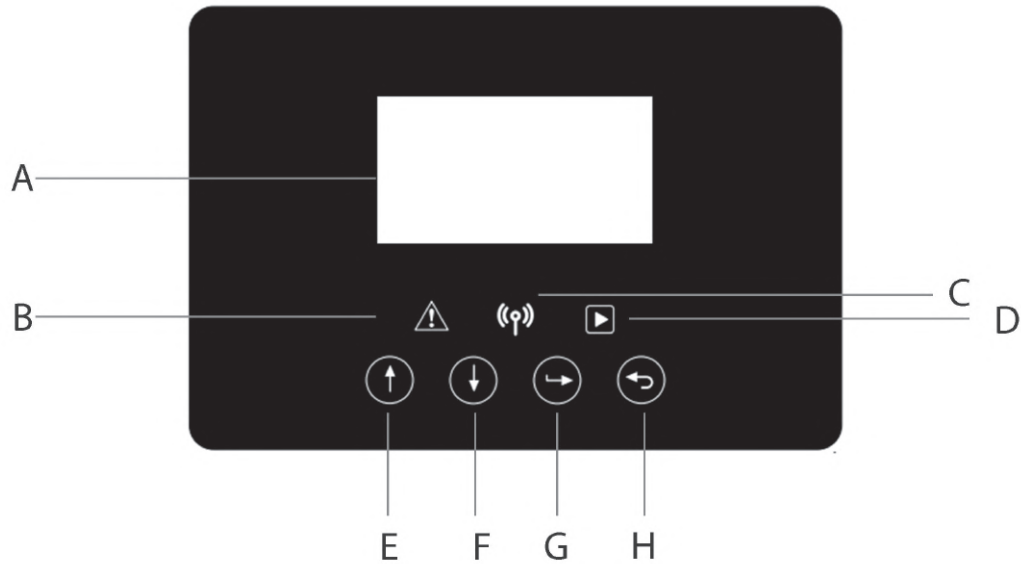

| Object | Name | Function |
|--------|-----------------|--|
| A | LCD screen | Display the information of the energy station. |
| B | Indicator LED | Red: The energy station is in fault mode. |
| C | | Blue: The energy station is normally connected to the battery. |
| D | | Green: The energy station is in normal state. |
| E | Function button | Up button: Move cursor to upside or increase value. |
| F | | Down button: Move cursor to downside or decrease value. |
| G | | OK button: Confirm the selection. |
| H | | Return button: Return the previous operation. |

8.2 Function Tree

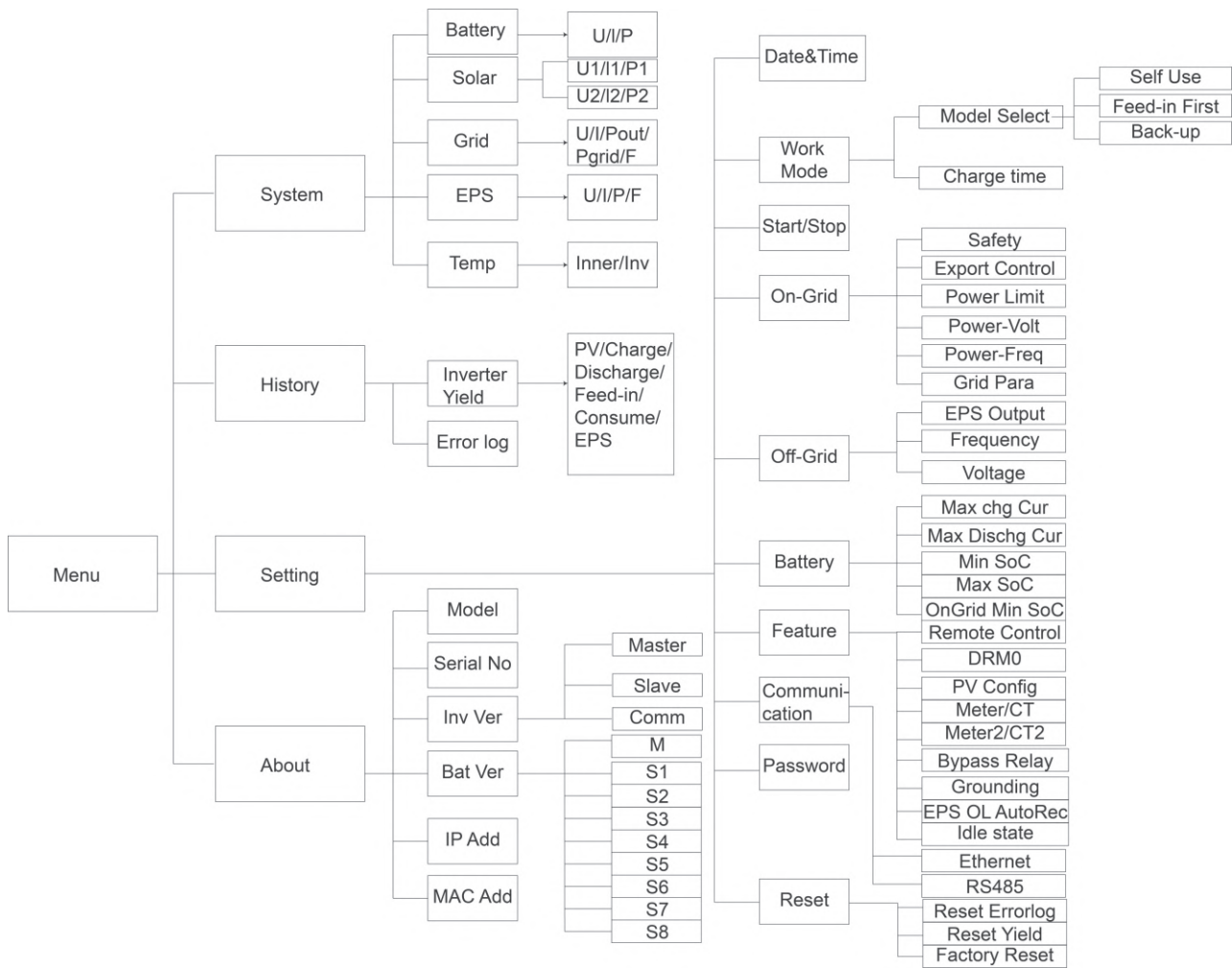

9. Maintenance

This section contains information and procedures for solving possible problems with the Fox energy stations and provides you with troubleshooting tips to identify and solve most problems that can occur.

9.1 Alarm List

| Fault Code | Solution |
|-----------------|---|
| Grid Lost Fault | Grid is lost. <ul style="list-style-type: none"> • System will reconnect if the utility is back to normal. • Or seek help from us, if not go back to normal state. |
| Grid Volt Fault | Grid voltage out of range. <ul style="list-style-type: none"> • System will reconnect if the utility is back to normal. • Or seek help from us, if not go back to normal state. |

| | |
|------------------|--|
| Grid Freq Fault | <p>Grid frequency out of range.</p> <ul style="list-style-type: none"> • System will reconnect if the utility is back to normal. • Or seek help from us, if not go back to normal state. |
| 10min Volt Fault | <p>The grid voltage is out of range for the last 10 Minutes.</p> <ul style="list-style-type: none"> • System will reconnect if the utility is back to normal. • Or seek help from us, if not go back to normal state. |
| SW Inv Cur Fault | <p>Output current high detected by software.</p> <ul style="list-style-type: none"> • Disconnect PV, grid and battery, then reconnect. • Or seek help from us, if not go back to normal state. |
| DCI Fault | <p>DC component is out of limit in output current.</p> <ul style="list-style-type: none"> • Disconnect PV, grid and battery, then reconnect. • Or seek help from us, if not go back to normal state. |
| HW Inv Cur Fault | <p>Output current high detected by hardware.</p> <ul style="list-style-type: none"> • Disconnect PV, grid and battery, then reconnect. • Or seek help from us, if not go back to normal state. |
| SW Bus Vol Fault | <p>Bus voltage out of range detected by software.</p> <ul style="list-style-type: none"> • Disconnect PV, grid and battery, then reconnect. • Or seek help from us, if not go back to normal state. |
| Bat Volt Fault | <p>Battery voltage fault.</p> <ul style="list-style-type: none"> • Check if the battery input voltage is within the normal range. • Or seek help from us. |
| SW Bat Cur Fault | <p>Battery current high detected by software.</p> <ul style="list-style-type: none"> • Disconnect PV, grid and battery, then reconnect. • Or seek help from us, if not go back to normal state. |
| Iso Fault | <p>The isolation is failed.</p> <ul style="list-style-type: none"> • Please check if the insulation of electric wires is damaged. • Wait for a while to check if back to normal. • Or seek for help from us. |
| Res Cur Fault | <p>The residual current is high.</p> <ul style="list-style-type: none"> • Please check if the insulation of electric wires is damaged. • Wait for a while to check if back to normal. • Or seek for help from us. |
| Pv Volt Fault | <p>PV voltage out of range.</p> <ul style="list-style-type: none"> • Please check the output voltage of PV panels. • Or seek for help from us. |
| SW Pv Cur Fault | <p>PV input current high detected by software.</p> <ul style="list-style-type: none"> • Disconnect PV, grid and battery, then reconnect. • Or seek help from us, if not go back to normal state. |
| Temp Fault | <p>The energy station temperature is high.</p> <ul style="list-style-type: none"> • Please check if the environment temperature. • Wait for a while to check if back to normal. • Or seek for help from us. |

| | |
|------------------|---|
| Ground Fault | <p>The ground connection is failed.</p> <ul style="list-style-type: none"> • Check the voltage of neutral and PE. • Check AC wiring. • Disconnect PV, grid and battery, then reconnect. • Or seek help from us, if not go back to normal state. |
| Over Load Fault | <p>Over load in on grid mode.</p> <ul style="list-style-type: none"> • Please check if the load power exceeds the limit. • Or seek for help from us. |
| Eps Over Load | <p>Over load in off grid mode.</p> <ul style="list-style-type: none"> • Please check if the eps load power exceeds the limit. • Or seek for help from us. |
| Bat Power Low | <p>The battery power is low.</p> <ul style="list-style-type: none"> • Wait the battery to be recharged. • Or seek for help from us. |
| HW Bus Vol Fault | <p>Bus voltage out of range detected by hardware.</p> <ul style="list-style-type: none"> • Disconnect PV, grid and battery, then reconnect. • Or seek help from us, if not go back to normal state. |
| HW Pv Cur Fault | <p>PV input current high detected by hardware.</p> <ul style="list-style-type: none"> • Disconnect PV, grid and battery, then reconnect. • Or seek help from us, if not go back to normal state. |
| HW Bat Cur Fault | <p>Battery current high detected by hardware.</p> <ul style="list-style-type: none"> • Disconnect PV, grid and battery, then reconnect. • Or seek help from us, if not go back to normal state. |
| SCI Fault | <p>The communication between master and manager is fail.</p> <ul style="list-style-type: none"> • Disconnect PV, grid and battery, then reconnect. • Or seek help from us, if not go back to normal state. |
| MDSP SPI Fault | <p>The communication between master and slave is fail.</p> <ul style="list-style-type: none"> • Disconnect PV, grid and battery, then reconnect. • Or seek help from us, if not go back to normal state. |
| MDSP Smpl Fault | <p>The master sample detection circuit is failed.</p> <ul style="list-style-type: none"> • Disconnect PV, grid and battery, then reconnect. • Or seek help from us, if not go back to normal state. |
| Res Cur HW Fault | <p>Residual current detection device is failed.</p> <ul style="list-style-type: none"> • Disconnect PV, grid and battery, then reconnect. • Or seek help from us, if not go back to normal state. |
| Inv EEPROM Fault | <p>The energy station eeprom is fault.</p> <ul style="list-style-type: none"> • Disconnect PV, grid and battery, then reconnect. • Or seek help from us, if not go back to normal state. |
| PvCon Dir Fault | <p>The PV connection is reversed.</p> <ul style="list-style-type: none"> • Check if the positive pole and negative pole of PV are correctly connected. • Or seek help from us. |

| | |
|-------------------------|--|
| Bat Relay Open | <p>The battery relay keeps open.</p> <ul style="list-style-type: none"> • Disconnect PV, grid and battery, then reconnect. • Or seek help from us, if not go back to normal state. |
| Bat Relay Short Circuit | <p>The battery relay keeps close.</p> <ul style="list-style-type: none"> • Disconnect PV, grid and battery, then reconnect. • Or seek help from us, if not go back to normal state. |
| Bat Buck Fault | <p>The battery buck circuit mosfet is fail.</p> <ul style="list-style-type: none"> • Disconnect PV, grid and battery, then reconnect. • Or seek help from us, if not go back to normal state. |
| Bat Boost Fault | <p>The battery boost circuit mosfet is fail.</p> <ul style="list-style-type: none"> • Disconnect PV, grid and battery, then reconnect. • Or seek help from us, if not go back to normal state. |
| Eps Relay Fault | <p>The eps relay is failed.</p> <ul style="list-style-type: none"> • Disconnect PV, grid and battery, then reconnect. • Or seek help from us, if not go back to normal state. |
| BatCon Dir Fault | <p>The battery connection is reversed.</p> <ul style="list-style-type: none"> • Check if the positive pole and negative pole of battery are correctly connected. • Or seek help from us. |
| Main Relay Open | <p>The grid relay keeps open.</p> <ul style="list-style-type: none"> • Disconnect PV, grid and battery, then reconnect. • Or seek help from us, if not go back to normal state. |
| S1 Close Fault | <p>The grid relay S1 keep close.</p> <ul style="list-style-type: none"> • Disconnect PV, grid and battery, then reconnect. • Or seek help from us, if not go back to normal state. |
| S2 Close Fault | <p>The grid relay S2 keep close.</p> <ul style="list-style-type: none"> • Disconnect PV, grid and battery, then reconnect. • Or seek help from us, if not go back to normal state. |
| M1 Close Fault | <p>The grid relay M1 keep close.</p> <ul style="list-style-type: none"> • Disconnect PV, grid and battery, then reconnect. • Or seek help from us, if not go back to normal state. |
| M2 Close Fault | <p>The grid relay M2 keep close.</p> <ul style="list-style-type: none"> • Disconnect PV, grid and battery, then reconnect. • Or seek help from us, if not go back to normal state. |
| GridV Cons Fault | <p>The grid voltage sample value between master and slave is not consistent.</p> <ul style="list-style-type: none"> • Disconnect PV, grid and battery, then reconnect. • Or seek help from us, if not go back to normal state. |
| GridF Cons Fault | <p>The grid frequency sample value between master and slave is not consistent.</p> <ul style="list-style-type: none"> • Disconnect PV, grid and battery, then reconnect. • Or seek help from us, if not go back to normal state. |

| | |
|------------------|--|
| Dci Cons Fault | <p>The dci sample value between master and slave is not consistent.</p> <ul style="list-style-type: none"> • Disconnect PV, grid and battery, then reconnect. • Or seek help from us, if not go back to normal state. |
| Rc Cons Fault | <p>The residual current sample value between master and slave is not consistent.</p> <ul style="list-style-type: none"> • Disconnect PV, grid and battery, then reconnect. • Or seek help from us, if not go back to normal state. |
| RDSP SPI Fault | <p>The communication between master and slave is fail.</p> <ul style="list-style-type: none"> • Disconnect PV, grid and battery, then reconnect. • Or seek help from us, if not go back to normal state. |
| RDSP Smpl Fault | <p>The slave sample detection circuit is failed.</p> <ul style="list-style-type: none"> • Disconnect PV, grid and battery, then reconnect. • Or seek help from us, if not go back to normal state. |
| ARM EEPROM Fault | <p>The manager eeprom is fault.</p> <ul style="list-style-type: none"> • Disconnect PV, grid and battery, then reconnect. • Or seek help from us, if not go back to normal state. |
| Meter Lost Fault | <p>The communication between meter and energy station is interrupted.</p> <ul style="list-style-type: none"> • Check if the communication cable between meter and energy station is correctly and well connected. |
| BMS Lost | <p>The communication between BMS and energy station is interrupted.</p> <ul style="list-style-type: none"> • Check if the communication cable between BMS and energy station is correctly and well connected. |
| Bms Ext Fault | <p>The communication between BMS and energy station is interrupted.</p> <ul style="list-style-type: none"> • Check if the communication cable between BMS and energy station is correctly and well connected. |
| Bms Int Fault | <p>DIP switch at the wrong position; The communication between battery packs is interrupted.</p> <ul style="list-style-type: none"> • Move the DIP switch to the correct position; • Check if the communication cable between battery packs is correctly and well connected. |
| Bms Volt High | <p>Battery over voltage.</p> <ul style="list-style-type: none"> • Please contact battery supplier. |
| Bms Volt Low | <p>Battery under voltage.</p> <ul style="list-style-type: none"> • Please contact battery supplier. |
| Bms ChgCur High | <p>Battery charge over current.</p> <ul style="list-style-type: none"> • Please contact battery supplier. |
| Bms DchgCur High | <p>Battery discharge over current.</p> <ul style="list-style-type: none"> • Please contact battery supplier. |
| Bms Temp High | <p>Battery over temperature.</p> <ul style="list-style-type: none"> • Please contact battery supplier. |

| | |
|-------------------|--|
| Bms Temp Low | Battery under temperature. • Please contact battery supplier. |
| BmsCellImbalance | The capacities of cells are different. • Please contact battery supplier. |
| Bms HW Protect | Battery hardware under protection. • Please contact battery supplier. |
| BmsCircuit Fault | Bms hardware circuit fault. • Please contact battery supplier. |
| Bms Insul Fault | Battery insulation fault. • Please contact battery supplier. |
| BmsVoltsSen Fault | Battery voltage sensor fault. • Please contact battery supplier. |
| BmsTempSen Fault | Battery temperature sensor fault. • Please contact battery supplier. |
| BmsCurSen Fault | Battery current sensor fault. • Please contact battery supplier. |
| Bms Relay Fault | Battery relay fault. • Please contact battery supplier. |
| Bms Type Unmatch | The capacity of battery packs is different. • Please contact battery supplier. |
| Bms Ver Unmatch | The software between slaves are different. • Please contact battery supplier. |
| Bms Mfg Unmatch | The cell manufacture is different. • Please contact battery supplier. |
| Bms SwHw Unmatch | The slave software and hardware are not match. • Please contact battery supplier. |
| Bms M&S Unmatch | The software between Master and Slave are not match. • Please contact battery supplier. |
| Bms ChgReq NoAck | No action for charging request. • Please contact battery supplier. |

9.2 Troubleshooting and Routine Maintenance

- Troubleshooting
 - a. Please check the fault message on the System Control Panel or the fault code on the energy station information panel. If a message is displayed, record it before doing anything further.
 - b. Attempt the solution indicated in table above.
 - c. If your energy station information panel is not displaying a fault light, check the following to make sure that the current state of the installation allows for proper operation of the unit:
 - (1) Is the energy station located in a clean, dry, adequately ventilated place?
 - (2) Have the DC input breakers opened?
 - (3) Are the cables adequately sized?
 - (4) Are the input and output connections and wiring in good condition?
 - (5) Are the configurations settings correct for your particular installation?
 - (6) Are the display panel and the communications cable properly connected and undamaged?

Contact Fox Customer Service for further assistance. Please be prepared to describe details of your system installation and provide the model and serial number of the unit.

- Safety check

A safety check should be performed at least every 12 months by a qualified technician who has adequate training, knowledge and practical experience to perform these tests. The data should be recorded in an equipment log. If the device is not functioning properly or fails any of the tests, the device has to be repaired. For safety check details, refer to section 2 of this manual.

- Maintenance checking list

During the process of using the energy station, the responsible person shall examine and maintain the machine regularly. The required actions are as follows.

- Check that if the cooling fins at the rear of the energy stations are collecting dust/dirt, and the machine should be cleaned when necessary. This work should be conducted periodically.
- Check that if the indicators of the energy station are in normal state, check if the display of the energy station is normal. These checks should be performed at least every 6 months.
- Check if the input and output wires are damaged or aged. This check should be performed at least every 6 months.
- Get the energy station panels cleaned and their security checked at least every 6 months.

Note: Only qualified individuals may perform the following works.

10. Decommissioning

10.1 Dismantling the Energy Station

- Disconnect the energy station from DC (for AIO-H1 only) Input and AC output. Wait for 5 minutes for the energy station to fully de-energize.
- Disconnect communication and optional connection wirings. Remove the energy station from the bracket.
- Remove the bracket if necessary.

10.2 Packaging

If possible, please pack the energy station with the original packaging. If it is no longer available, you can also use an equivalent box that meets the following requirements.

- Suitable for loads more than 30 kg.
- Contains a handle.
- Can be fully closed.

10.3 Storage and Transportation

Store the energy station in dry place where ambient temperatures are always between -40°C - $+70^{\circ}\text{C}$. Take care of the energy station during the storage and transportation; keep less than 4 cartons in one stack. When the energy station or other related components need to be disposed of, please ensure it is carried out according to local waste handling regulations. Please be sure to deliver any energy station that needs to be disposed from sites that are appropriate for the disposal in accordance with local regulations.

The copyright of this manual belongs to FOXESS CO., LTD. WUXI BRANCH. Any corporation or individual should not plagiarize, partially or fully copy (including software, etc.), and no reproduction or distribution of it in any form or by any means is permitted. All rights reserved.

FOXESS CO., LTD. WUXI BRANCH

Add: No.11, Lijiang Road, Xinwu District, Wuxi,

Jiangsu Province, China

Tel: 0510- 68092998

WWW.FOX-ESS.COM.