

3KVA/5KVA-230V

Service manual

Table of contents

1. General information.....	3
1.1 Getting start.....	3
1.2 Basic topology introduction.....	3
1.3 Inverter family.....	4
1.4 Overview the inverter.....	4
1.5 PCB overview.....	5
2. Troubleshooting.....	6
2.1 How to do.....	6
2.2 Check the fault information.....	6
2.3 Fault condition.....	7
2.4 Test step.....	8
3. Checking and measuring guide.....	9
3.1 Check the battery side components.....	9
3.2 Check the bus side components.....	16
3.3 Check the buck circuit.....	18
3.4 Check the INV full bridge.....	20
3.5 Check the MPPT board.....	22
4. Disassembling guide.....	23
4.1 Remove the REMOTE BOX.....	23
4.2 Open the case.....	23
4.3 Remove all boards.....	錯誤! 尚未定義書籤。
5. Cables connection.....	27

1. General information

1.1 Getting start

This manual is used as a checking and repairing guide for 3KVA/5KVA-230V model. Before read this manual, it's better to have some electrical or electronic background knowledge. With this guide, you can fix the inverter by yourself firstly.

There are five main parts of this guide:

General information: This part is the basic information of the inverter; you can start to know the inverter from this chapter.

Troubleshooting: This part will tell you how to do when you face a problem.

Checking and measuring guide: This part will teach you how to check or repair the inverter by measuring the critical components.

Assembling guide: This part teaches you how to take the board outside and fix the new one.

Cables connection: This part is a reference for cable connection.

1.2 Basic topology introduction

The topology of the inverter shows as below:

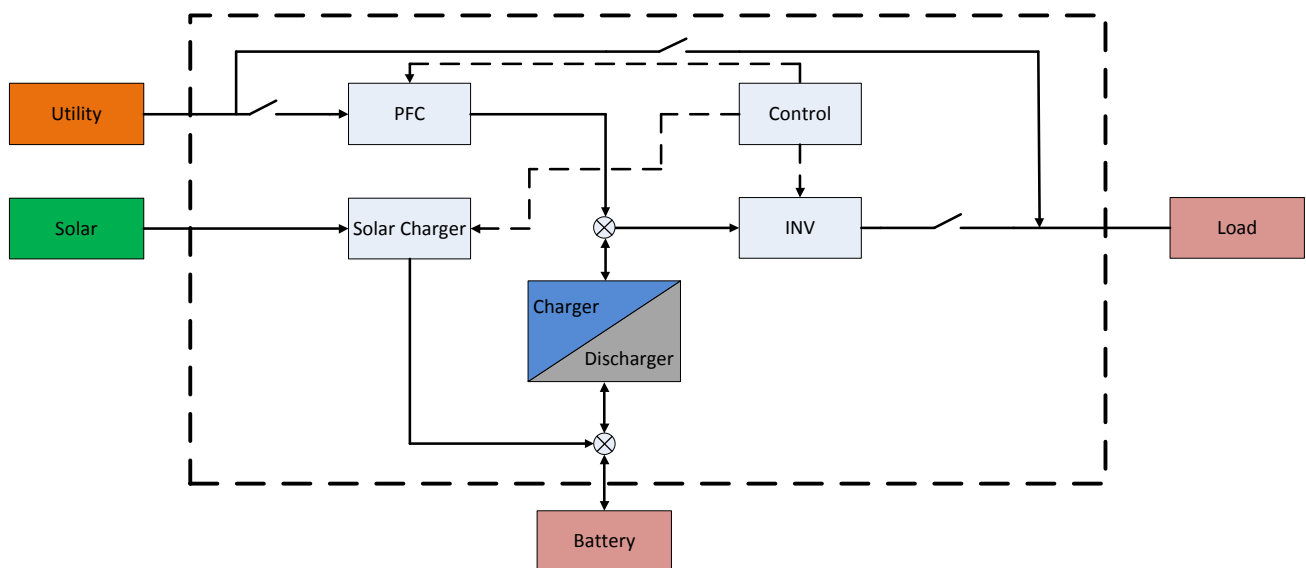

Compare with UPS or normal inverter, INVERTER combines a solar charger inside. Solar charger can be a supplement for battery when there is not grid or for saving energy purpose. And with the solar charger, the inverter can have more working modes than UPS. For detail information please refer to our user manual.

1.3 Inverter family

This service manual includes different models of the inverter, the table as below contains some important parameters with different models.

These models names are only neutral names; please match the real model name of your inverter to the model name in the table by comparing the typical characteristics.

Model name	Power rating	Solar charger type	Solar charger number	Off-grid/Hybrid
3KVA	3KVA/3KW	MPPT	1	Off-grid
5KVA	5KVA/5KW	MPPT	1	Off-grid

Note: Main board of 3KVA model is 16-501021-XXG, main board of 5KVA model is 16-501016-XXG.

1.4 Overview the inverter

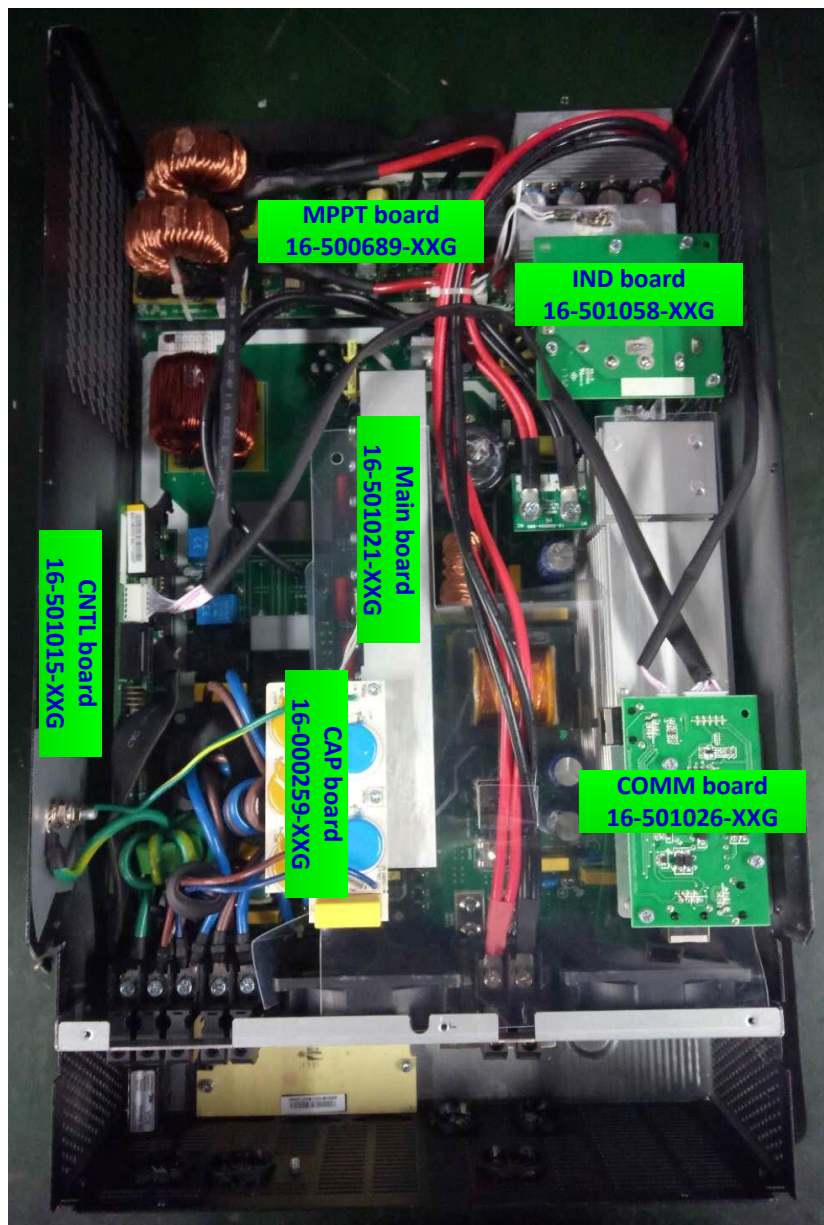

1.5 PCB overview

Main board:

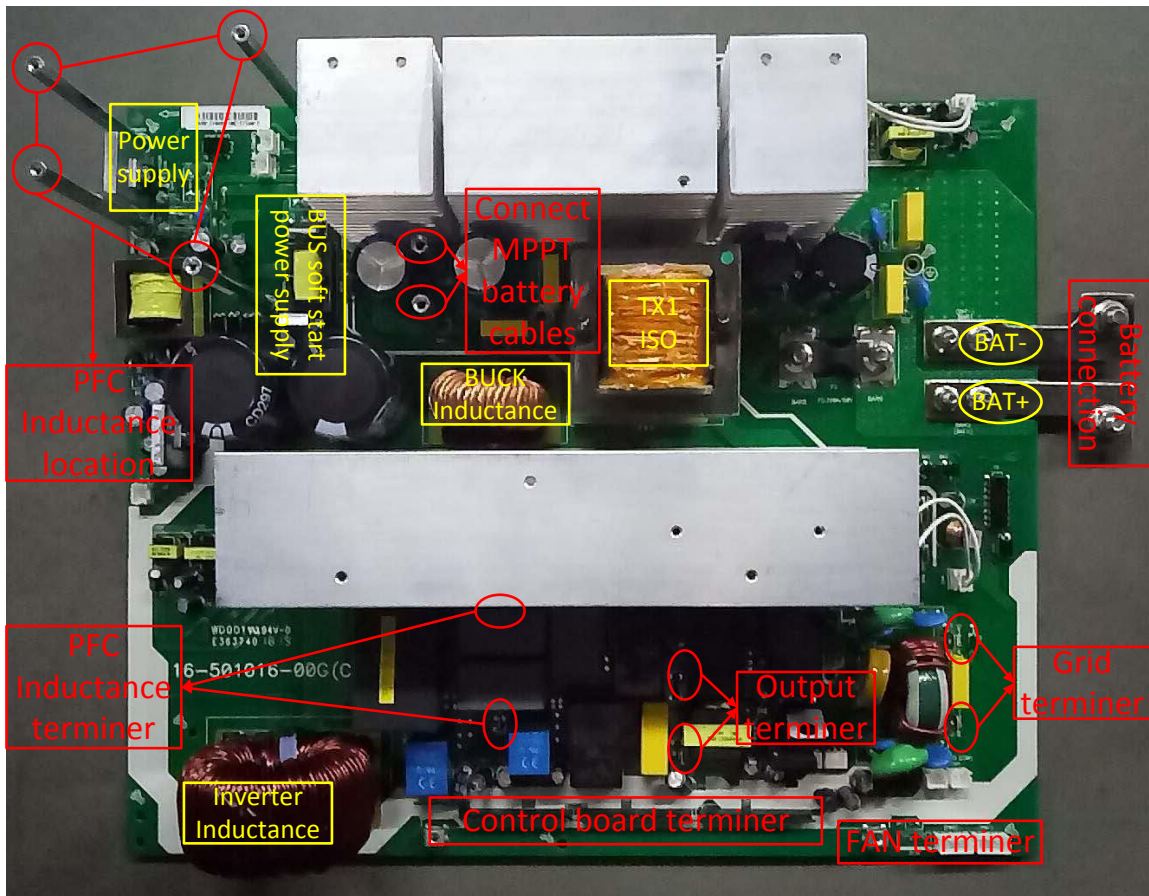

Control board:

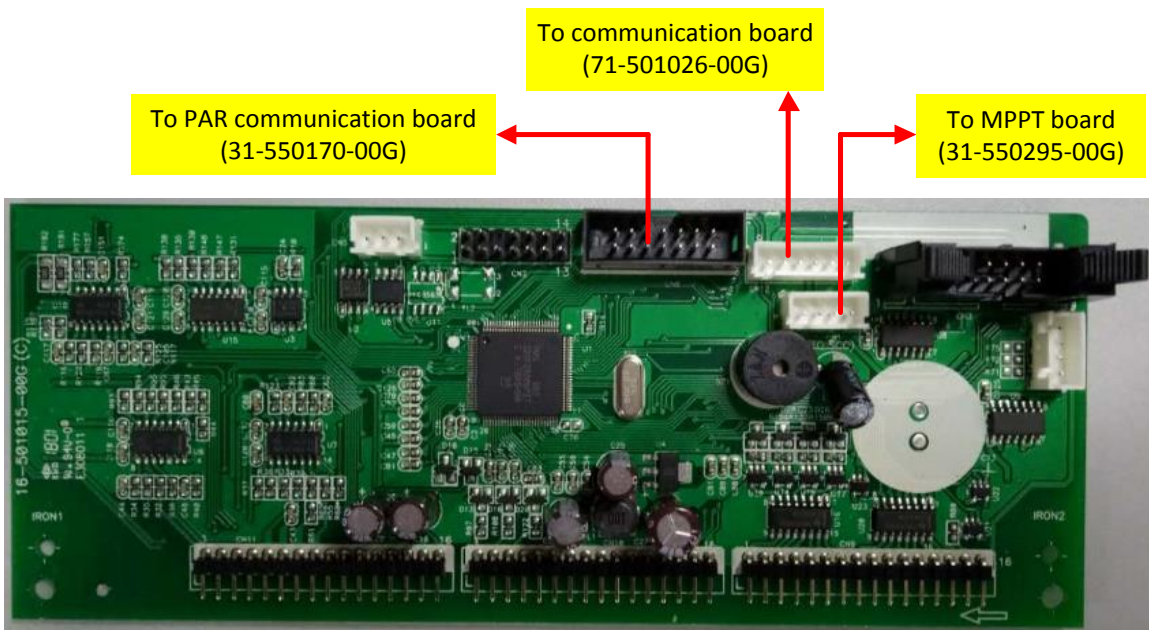

MPPT board:

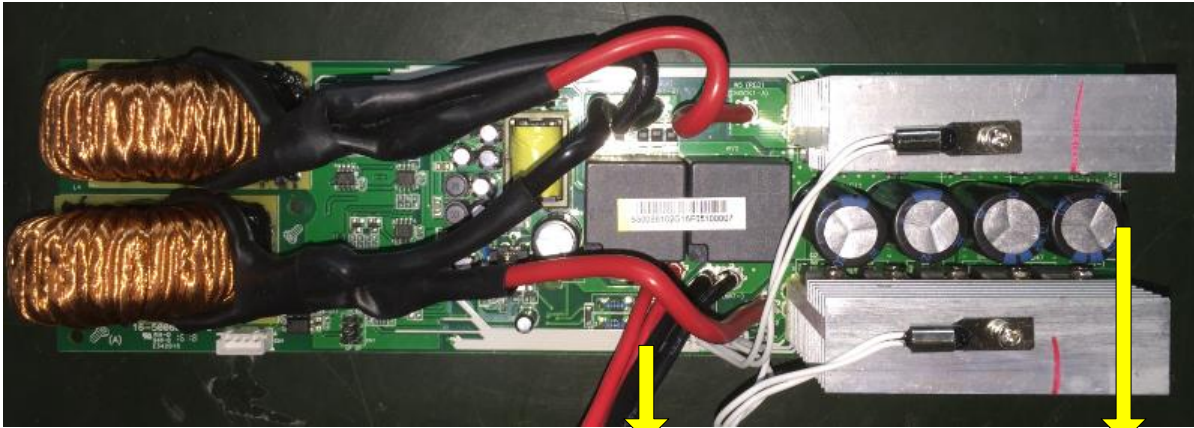

Battery connection

Solar connection

2. Trouble shooting

2.1 How to do

When the inverter was faulty, normally there are two main symptoms:

- No display at all;
- Fault code or warning code on the LCD;

When the fault occurred, please help to record the fault information and follow “How to check” of part 2.3 to check the inverter, then feedback the checking result to the service center. It will be very helpful for solving the problem as soon as possible.

2.2 Check the fault information

Please follow the steps as below to find the issues!

Make sure that you can finish all the steps and feedback us the results. Or we may not be able to give you the right solution.

Step 1: Test the battery working mode.

Before turning on the inverter, only connect the battery with the inverter which means no solar input and grid input. Turn on the switch, the LCD will light up and wait for the battery connecting to load.

If the connection is failed, please record the fault code.

Step 2: Test the grid charging mode.

Before turning on the inverter, only connect the utility and battery with the inverter. Without press any buttons, the LCD will light up. And wait for the utility connecting to battery.

If the connection is failed, please record the fault code.

Step 3: Test the solar charging mode.

Before turning on the inverter, only connect the solar and battery with the inverter. Without press any buttons, the LCD will light up. And wait for the solar connecting to battery.

If the connection is failed, please record the fault code.

2.3 Fault condition

Note:

When open the top cover, please have a look first, are there any obviously damaged parts?

When take the main board out, please have a look around, are there any obviously damaged parts?

2.2.1. Not working at all/ No display

Description	The inverter couldn't startup completely.
Possible reason	1. SPS module damaged.
How to check	1. Firstly, please measure the resistor between BAT+ and BAT-. If it is not shorted, only connect the inverter with battery, and press "ON" button, could the inverter startup? If not, please check the fan. 2. If the LCD couldn't light up and fan doesn't work, please disconnect all the wires and open the top cover, and then take the main board outside by following part 4.
How to solve	Replace the main board.

2.2.2. 09 fault

Description	Bus soft start fails.
Possible reason	DC-DC module was damaged.
How to check	Check the main board by following "3.1~3.4";
How to solve	Repair the main board or replace it directly.

2.2.3. 56 fault

Description	Battery couldn't be detected.
Possible reason	Wire connection or fuse was burnt.
How to check	1. Check the wire connection, the priority of the battery cable; 2. Check the main board by following "3.1".
How to solve	Repair the main board or replace it directly.

2.4 Test step

After replacing all defected components, testing steps can be used to confirm the repair result and the reliability of the Inverter.

Set up the testing system as below:

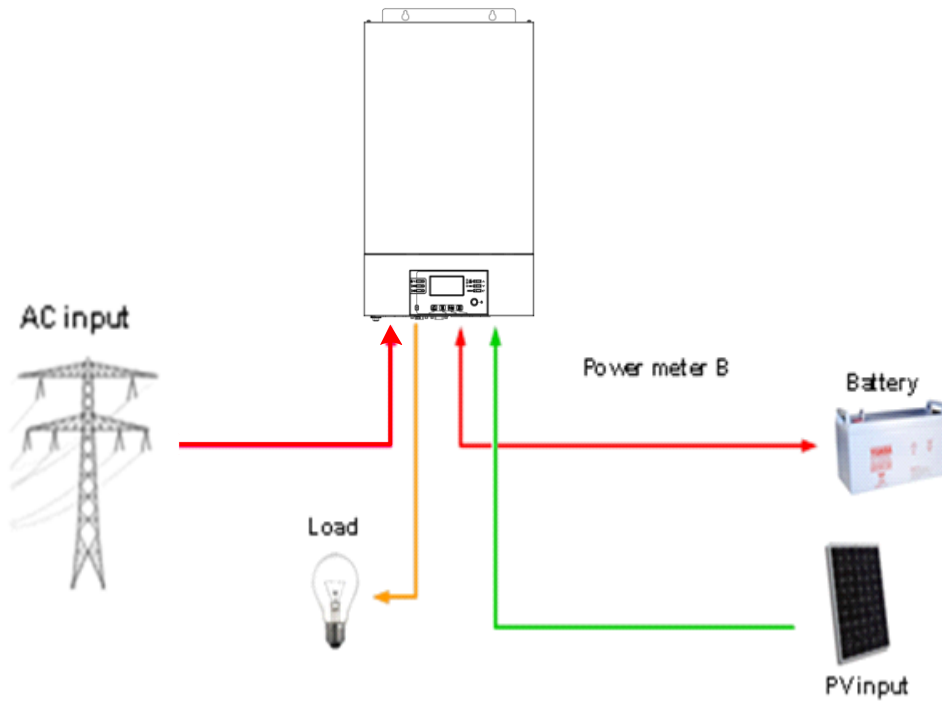

3. Checking and measuring guide

3.1 Check the battery side components

Fuse and capacitors

F3



Parts	Attribute	Reference values	Failure status
F3	Resistor	0 ohm	Open

C9/C13/C8/C12

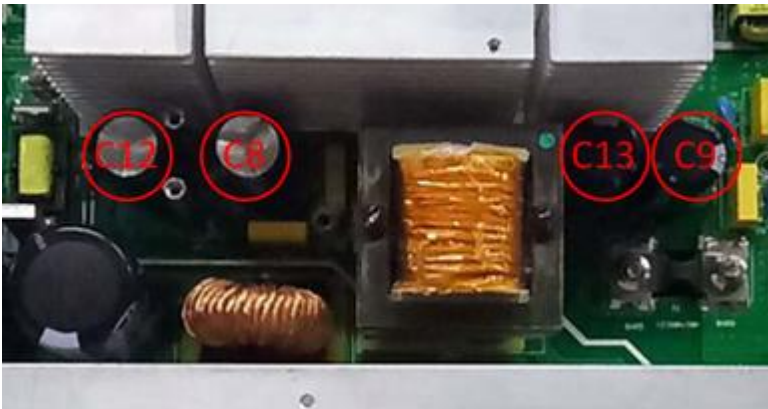

If the capacitors explode as below, they need to be replaced.



Power devices

DC/DC MOSFET: Q13/Q18/Q23 & Q11/Q17/Q20 & Q21/Q22/Q12 & Q26/Q25/Q14

SERVICE MANUAL

3KVA/5KVA-230V

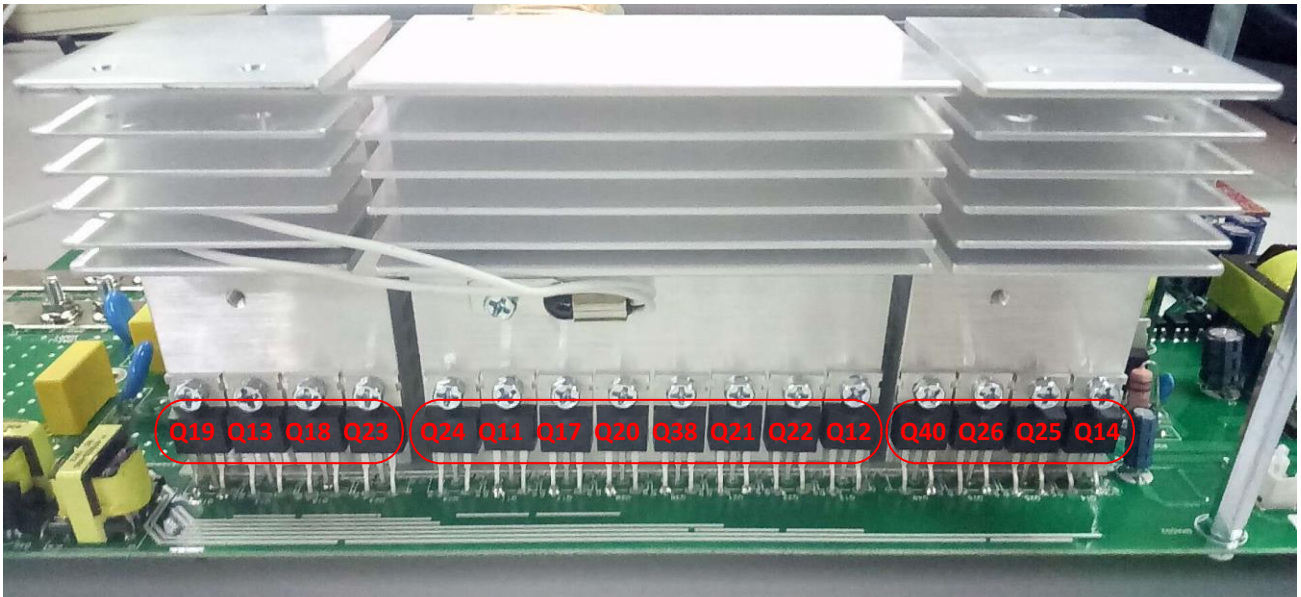

Parts	Attribute	Reference values	Failure status
All:	Resistor ¹	GS: 11.7K GD: 250K DS: 0.55M	Short or explosion
	Diode	SD: 0.42V DS: OL	

Note1: When you use the multimeter to measure the resistor of the transistor, because of the capacitor in the circuit, it will cause the changing of the values when you measure the DS and GD. So we recommend you measure the diode forward voltage of SD, and the resistor of GS. These two values can reflect the situation of the transistor more correctly.

Note: If one or more of them were damaged, please replace all of them.

3.1.1. Drivers (This part is only used for repair checking)

Note: Drivers usually need to be checked when users want to repair the boards. Because when power devices were damaged, the high voltage will rush to driver circuit through the gates of power devices.

The reference of the resistors list as below:

R41/R59/R70/R76/R80/R78/R75/R42/R52/R62/R81/R64/R93/R92/R87/R53

TVS1/ TVS2/ TVS3/ TVS4/ TVS6/ TVS7/ TVS8/ TVS10/ TVS11/ TVS12/ TVS14/ TVS15/ TVS16

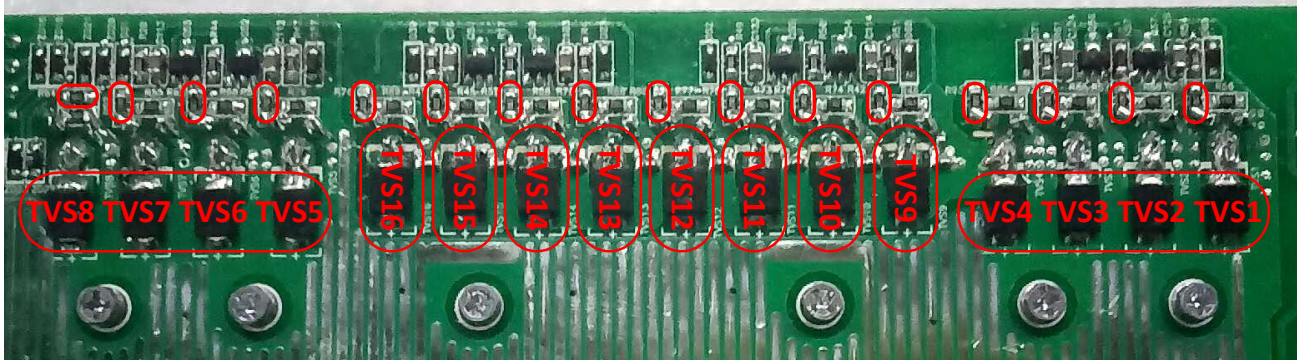

Use multimeter to measure each resistor, find the burnt resistors and replace them; don't need to replace them all.

model	Parts	Attribute	Reference values	Failure status
3KVA	All: 33ohm	Resistor	33 ohm	Open or other values
	TVS1-16	Diode	+ To - : 0.42V	Short or explosion
5KVA	All: 22ohm	Resistor	22 ohm	Open or other values
	TVS1-16	Diode	+ To - : 0.42V	Short or explosion

If the resistors need to be replaced, please also check the driver transistors and control IC.

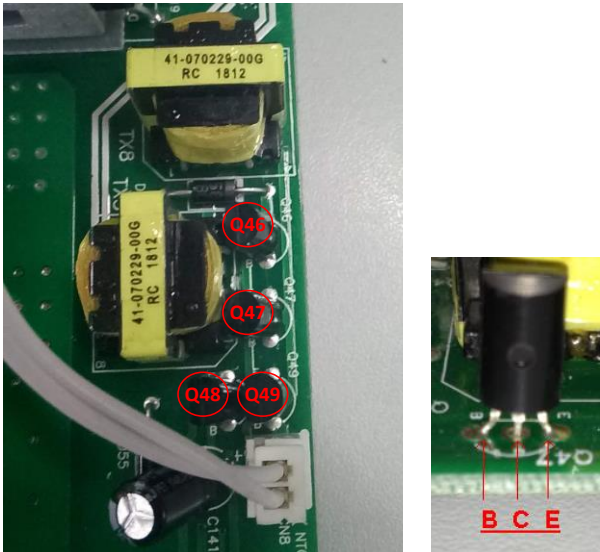

The Q46 and Q48 are 11-300012-00G (TR 2A 50V NPN TO-92)

The Q47 and Q49 are 11-300005-00G (TR 2A 50V PNP TO-92NL)

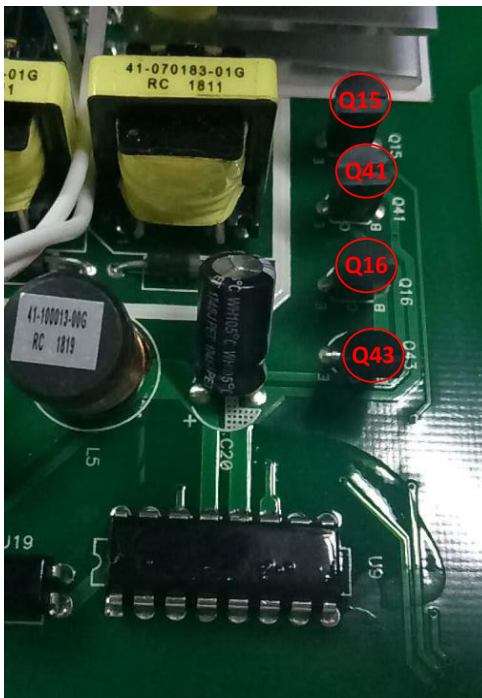

The Q41 and Q43 are 11-300012-00G (TR 2A 50V NPN TO-92)

The Q15 and Q16 are 11-300005-00G (TR 2A 50V PNP TO-92NL)

Parts	Attribute	Reference values	Failure status
Q46/Q48/Q41/Q43	Resistor	BE: 434.2k BC: 429.3k CE: 19.52k	Short or explosion

SERVICE MANUAL

3KVA/5KVA-230V

	Diode	BE: 0.656V BC: 0.655V CE: 1.3V	
Q47/Q49/Q15/Q16	Resistor	BE: 433.5k BC: 432.1k CE: 8.1k	Short or explosion
	Diode	BE: 0.656V BC: 1.741V CE: 0.2V	

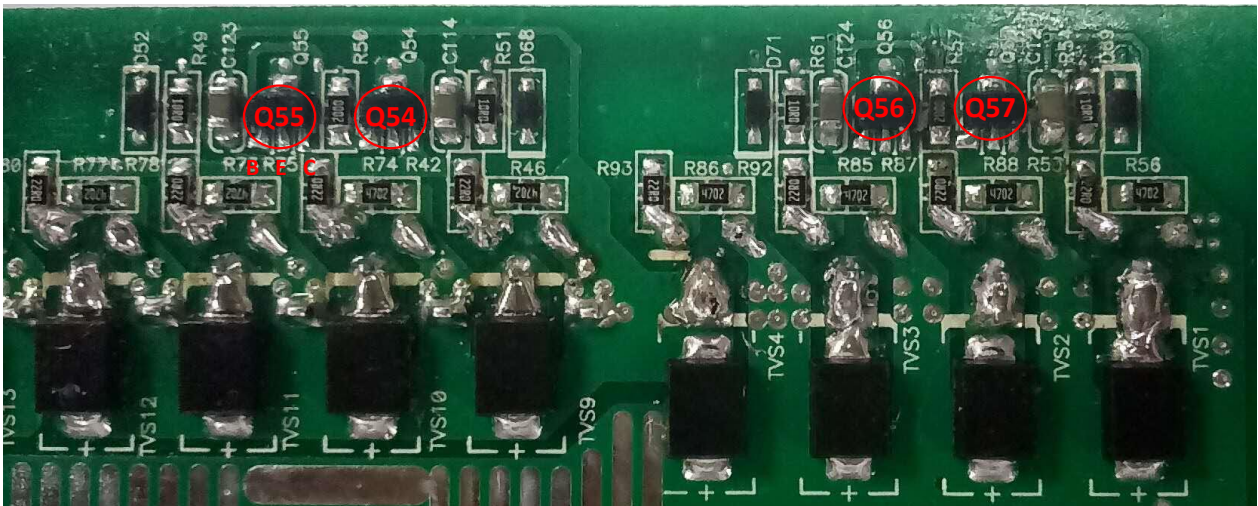

The Q54 and Q56 are 11-40011-00G (TR 2A 50V NPN SOT-89)

The Q55 and Q57 are 11-40010-00G (TR 3A 50V PNP SOT-89)

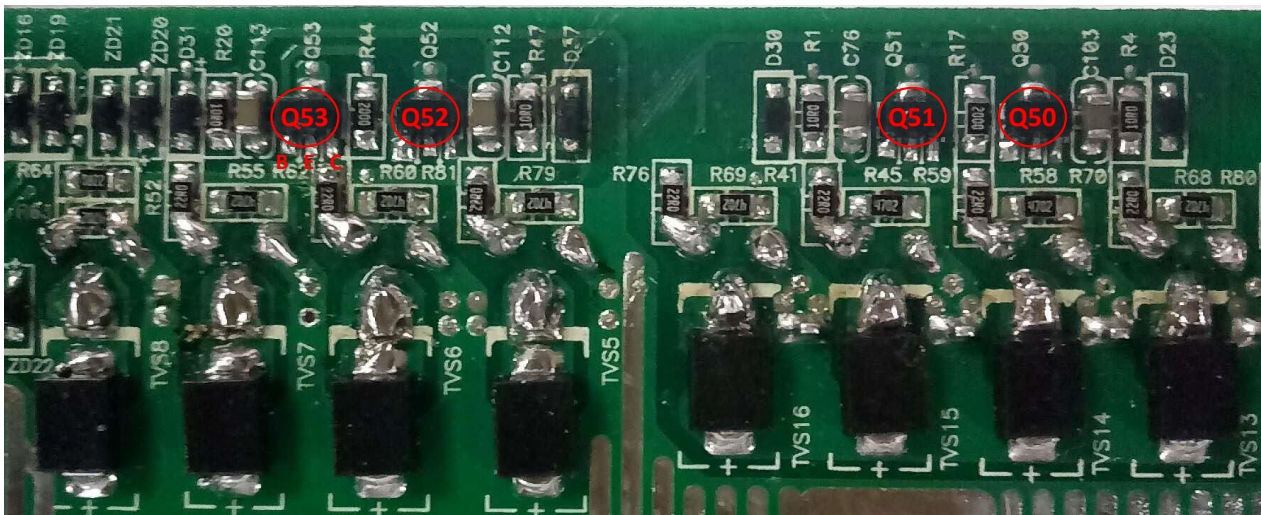

The Q51 and Q52 are 11-40011-00G (TR 2A 50V NPN SOT-89)

The Q50 and Q53 are 11-40010-00G (TR 3A 50V PNP SOT-89)

SERVICE MANUAL

3KVA/5KVA-230V

Parts	Attribute	Reference values	Failure status
Q54/Q56/Q51/Q52	Resistor	BE: 12k BC: 263.5K CE: OL	Short or explosion
	Diode	BE: 0.632V BC: 0.631V CE: OL	
Q55/Q57/Q50/Q53	Resistor	BE: 12k BC: OL CE: 277.3k	Short or explosion
	Diode	BE: 0.632V BC: OL CE: 1.107V	

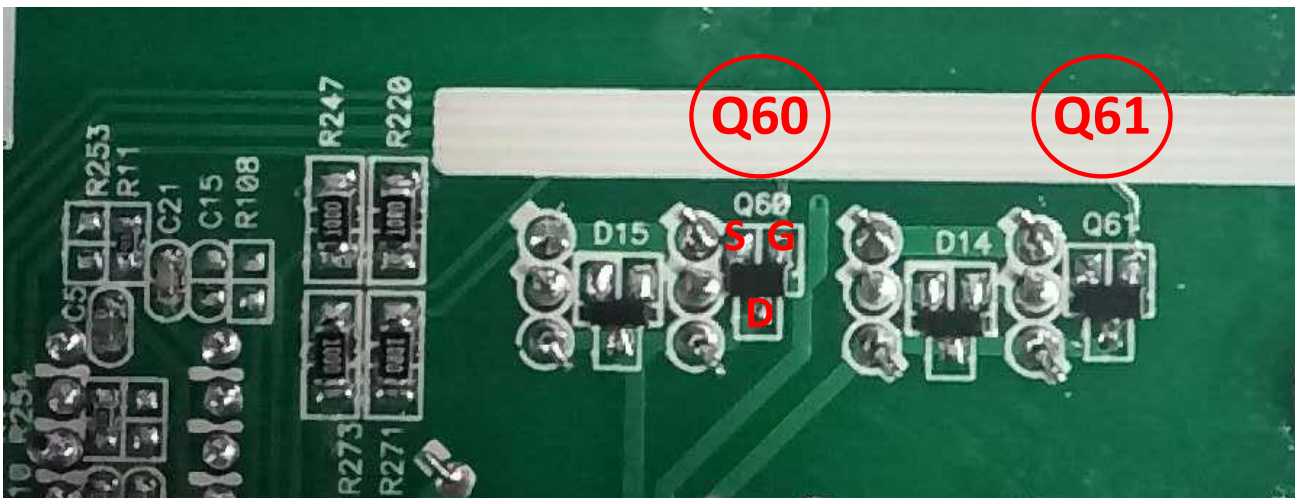

The Q60 and Q61 are 11-420007-00G (MOSFET 5.8A 30V SOT-23)

Parts	Attribute	Reference values	Failure status
Q60/Q61	Resistor	GS: 4.185k GD: 12.08k DS: 90k	Short or explosion
	Diode	SD: 0.207V DS: 1.389V	

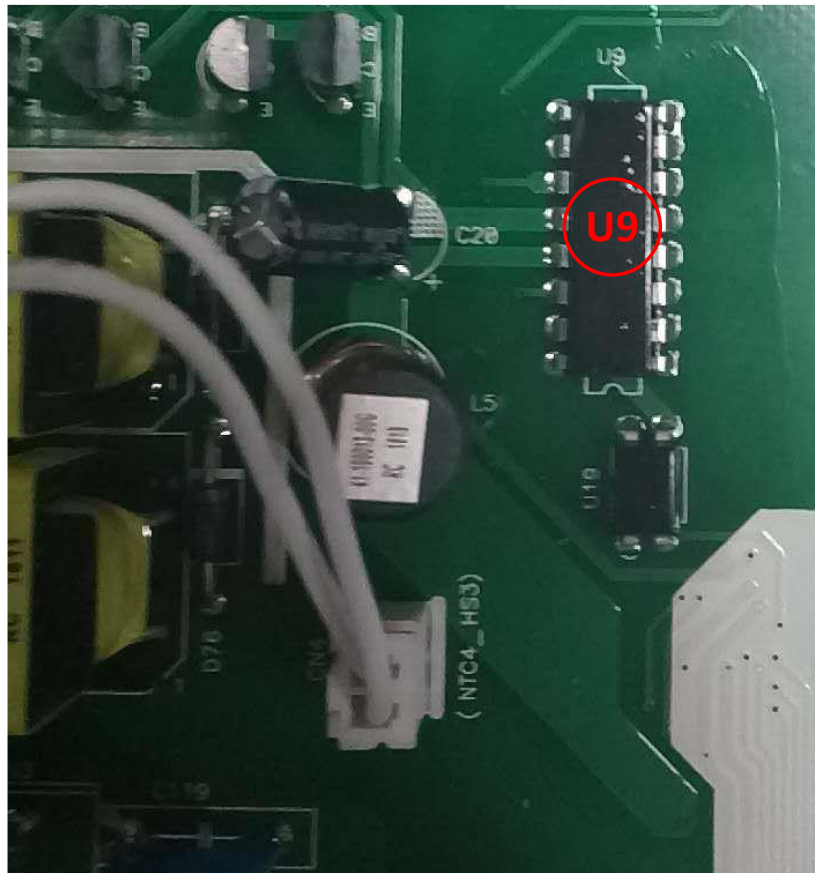

Parts	Attribute	Reference values	Failure status
U9	Resistor	Pin13TOPin12:100~300k Pin11 TO Pin12: 438k Pin14 TO PIN12: 438k	Short or explosion
Note: If you are not sure about these components, we recommend you replacing them all.			

3.2 Check the bus side components

Power devices

DC/DC IGBT: Q30/Q29/Q27/Q28

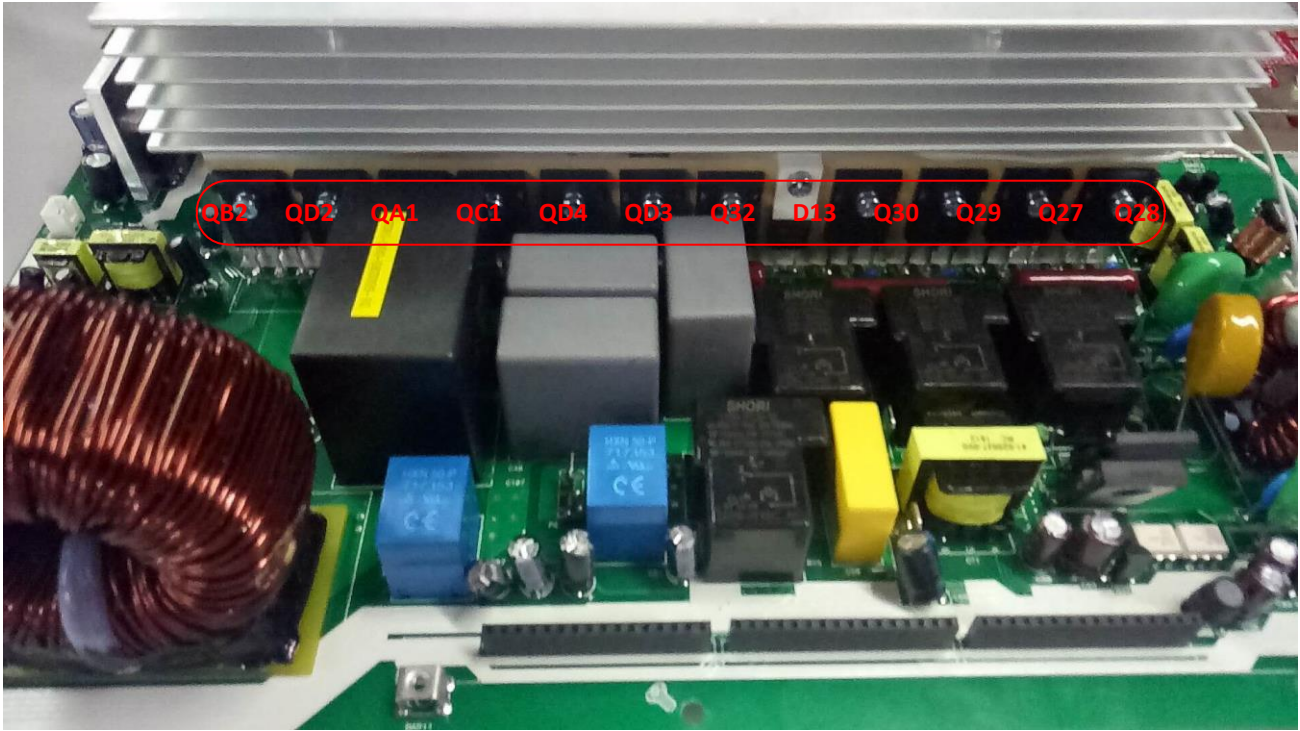

Parts	Attribute	Reference values	Failure status
Q27/Q28/Q29/Q30	Resistor ¹	GE: 47.8 ohm GC: 178.5K CE:35M	Short or explosion
	Diode	EC: 0.37V CE: OL	

Note1: When you use the multimeter to measure the resistor of the transistor, because of the capacitor in the circuit, it will cause the changing of the values when you measure the CE and GE. So we recommend you measure the diode forward voltage of EC, and the resistor of GE. These two values can reflect the situation of the transistor more correctly.

Note: If one or more of them were damaged, please replace all of them.

Drivers (This part is only used for repair checking)

Meanwhile, we also need to check the driver tubes of these power tubes.

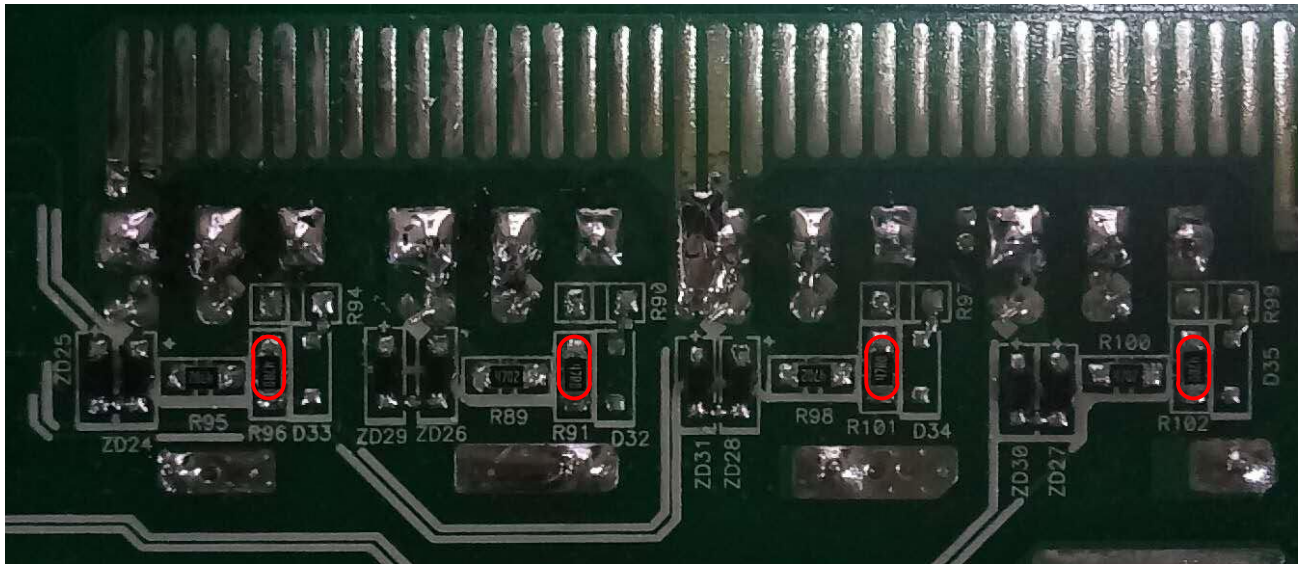

Parts	Attribute	Reference values	Failure status
R96/R91/R101/R102	Resistor	47 ohm	Open or other values
<p>Note2: When test the diode; please remove the R90/R99/R94/R97 from the board, or the test result is not right.</p>			

3.3 Check the buck circuit

Power devices

BUCK MOSFET and Diode: Q32 / D13

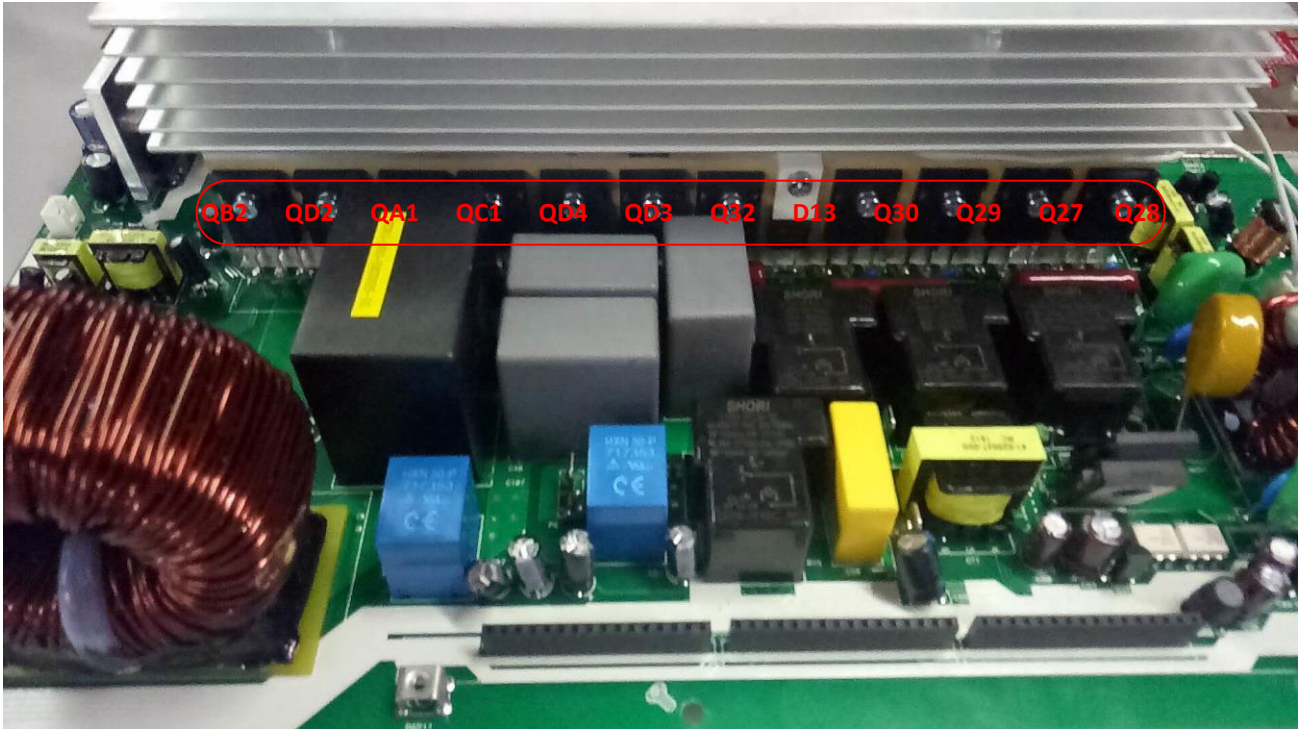

Parts	Attribute	Reference values	Failure status
Q32	Resistor	GE: 22.7 K GC: 225.3K CE: 1.25M	Short or explosion
	Diode	SD or CE: 0.37V DS or EC: OL	
D13	Resistor	+ to -: 178K - to +: 15M	
	Diode	+ to -: 0.37V - to +: OL	

Drivers (This part is only used for repair checking)



Parts	Attribute	Reference values	Failure status
R125	Resistor	47 ohm	Open or other values
Note: When test the diode; please remove the R124 from the board, otherwise the test result is not right.			

3.4 Check the INV full bridge

Power devices

INV&PFC IGBT: QB2/QD2/QA1/QC1/QD4/QD3

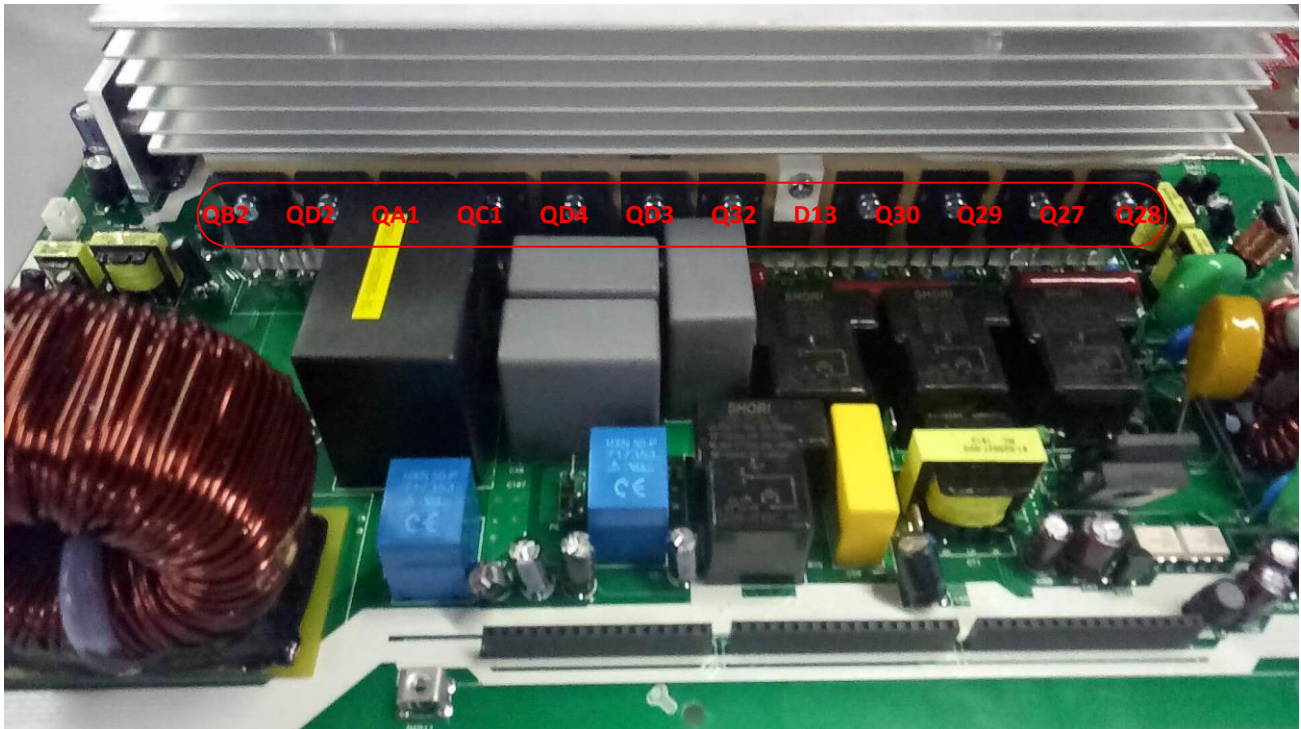

Parts	Attribute	Reference values	Failure status
QB2/QD2	Resistor	GE: 22.5K	Short or explosion
QA1/QC1		GC: 250k	
QD4/QD3	CE: 1.1M		
	Diode	EC: 0.37V	
		CE: OL	

Note1: If one or more of them were damaged, please replace all of them.

SERVICE MANUAL

3KVA/5KVA-230V

Drivers

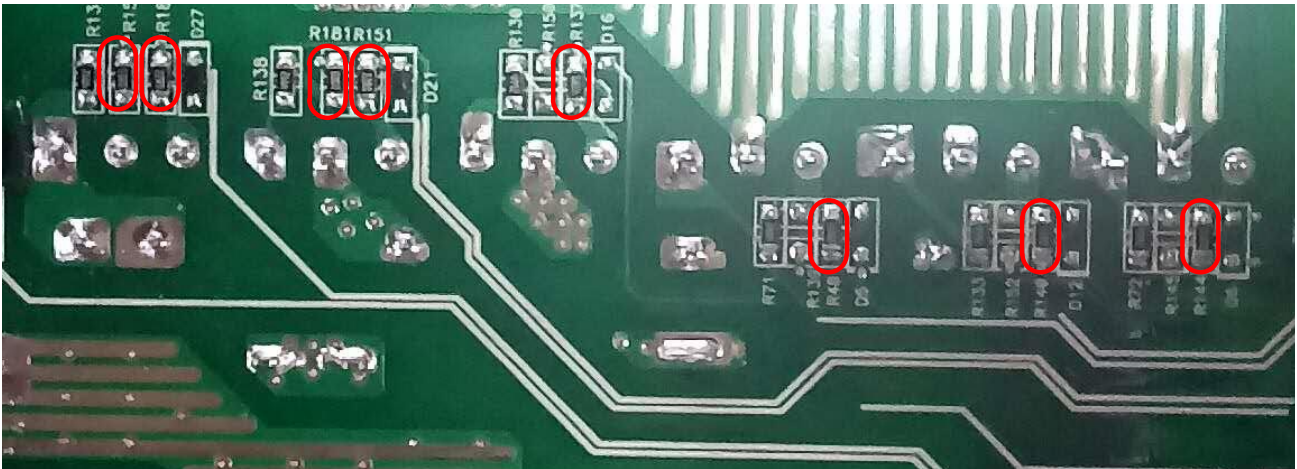

Parts	Attribute	Reference values	Failure status
R144/R48/R140/R137	Resistor	47 ohm	Open or other values
R151/R189	Resistor	22 ohm	Open or other values
R153/R181	Resistor	10 ohm	Open or other values

Optocoupler: U6/U12/U2/U4/U3/U1/U11

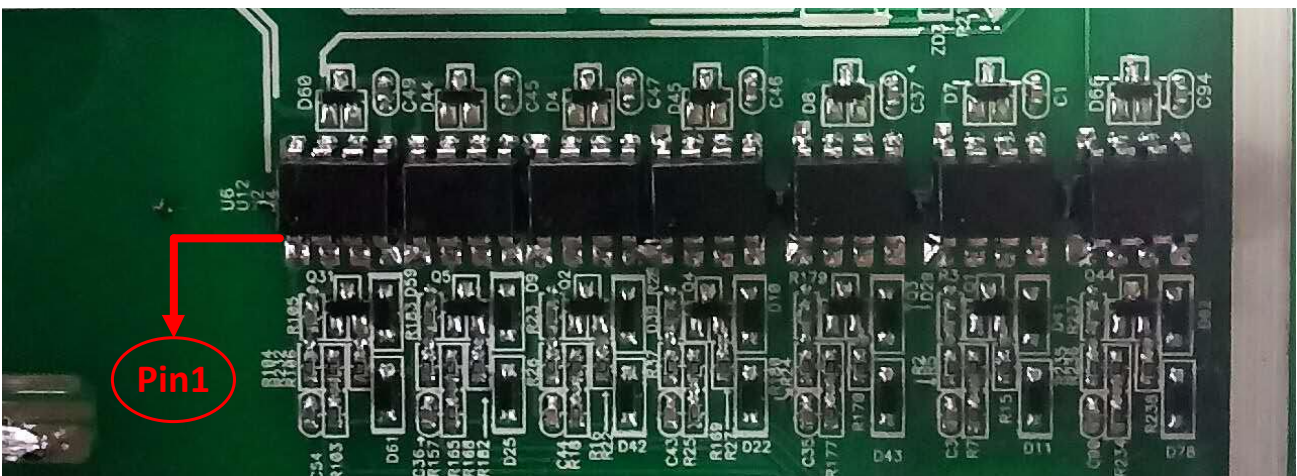

Parts	Attribute	Reference values	Failure status
U6/U12/U2/U4/U3/U1/U11	Resistor	PIN8 TO PIN5: 0.94M PIN7 TO PIN5: 0.97M	Short or explosion

3.5 Check the MPPT board

Power devices

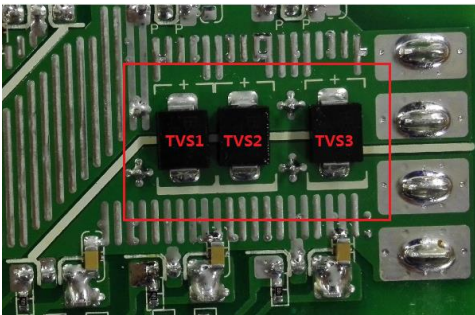

Parts	Attribute	Reference values	Failure status
Q2, Q3, Q4, Q10, Q11, Q13	Resistor	GS: 4.964k GD: 37.2k DS: 260.0k	Short or explosion
	Diode	SD: 0.45V DS: OL	
D8, D49, D48, D47, D24, D4	Resistor	+ to -: 1.07k - to +: 1 Meg	Short or explosion
	Diode	+ to -: 0.167V - to +: OL	
TVS1, TVS2, TVS3	Resistor	223.3k ohm	Short

4. Disassembling guide

4.1 Remove the REMOTE BOX

Loosen the screw on the two sides of bottom case and push up the case cover. Then, remove screw on the top of the display panel. Now, the display can be removed from the bottom case. Then, pull out the cable from the remote communication port.

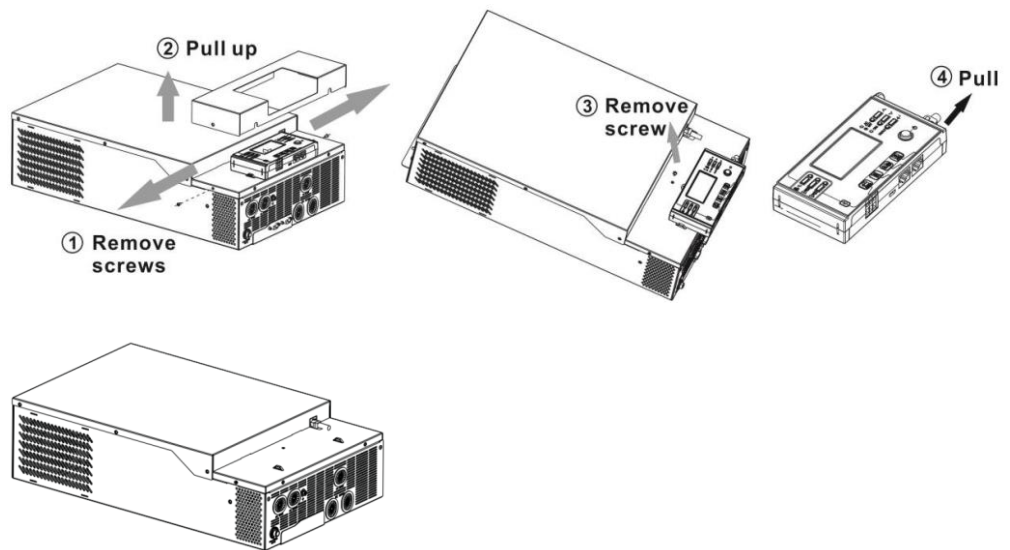

4.2 Open the case

Remove screws on the top cover, and then open the top cover carefully.

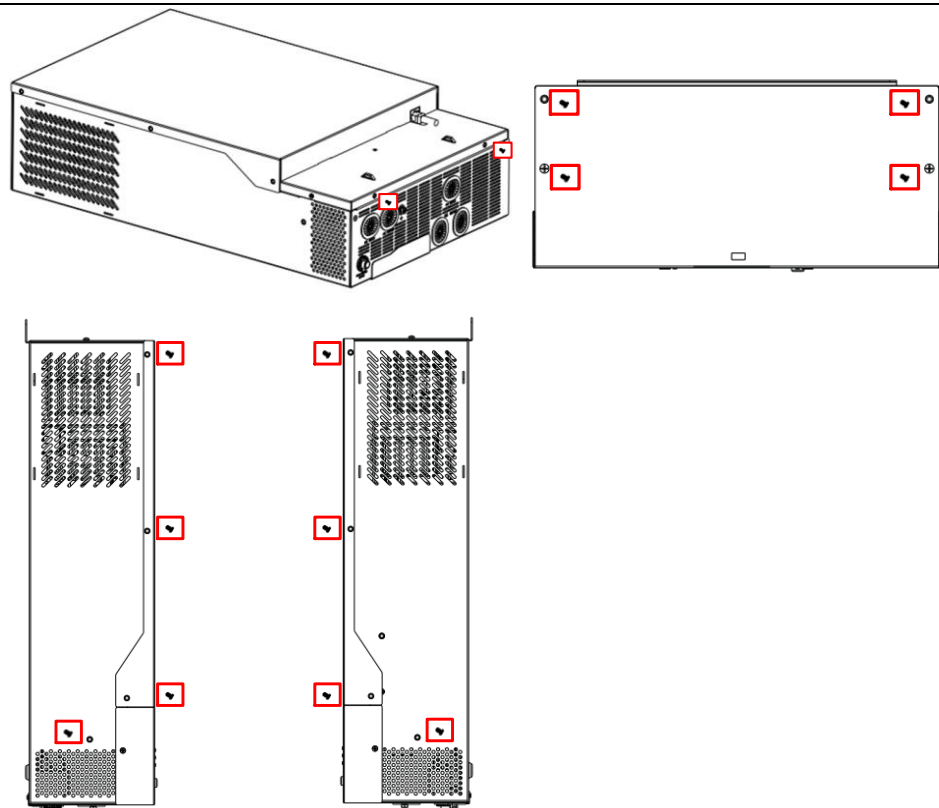

4.3 Remove all boards

Remove the two screws and the signal cables, then take out the COMM board;

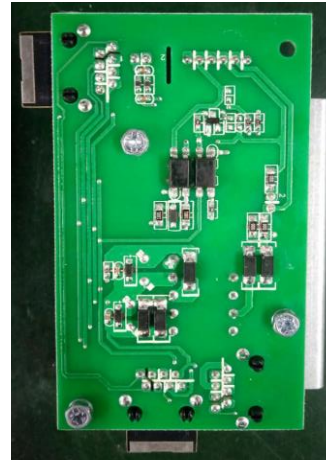

Remove the two screws, then put the COMM board on the side;
Remove the two copper pillars;

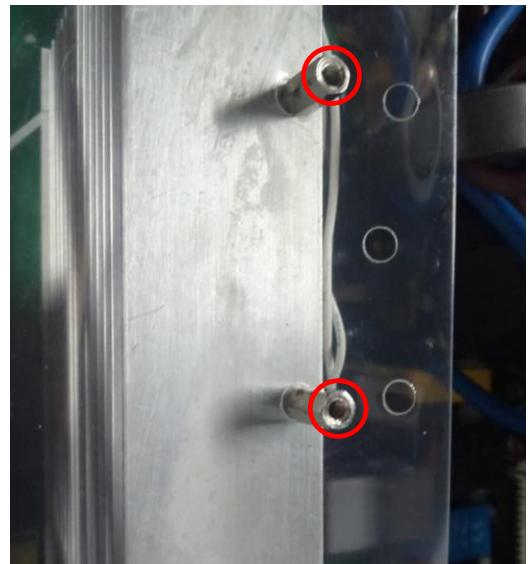

Remove the four screws, you can take the small board and the fan paper off;

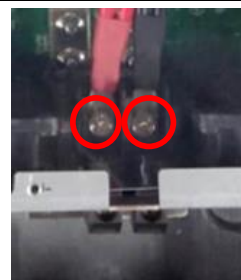

SERVICE MANUAL

3KVA/5KVA-230V

Remove the four screws and two black cables, you can take the IND board off;



Remove the two screws and the signal cables, you can take the control board off;



Remove all cables here (AC In/Out cables, GND cables, Signal cables, FAN cables).
Brown cable is line;
blue cable is neutral.

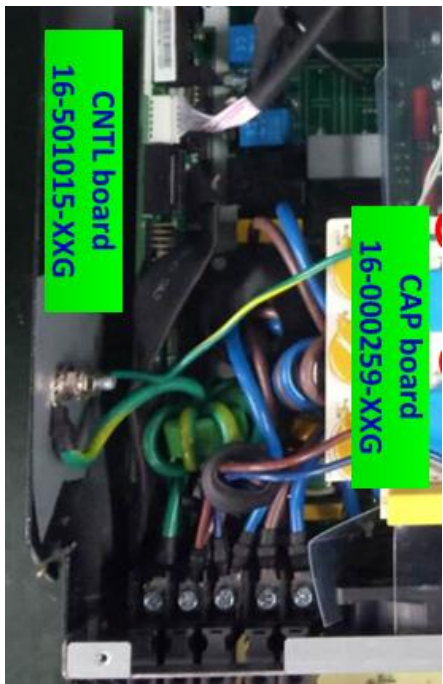

Remove the screws, and then you can take the main board out.

Note: There are ten screws to fix the main board.

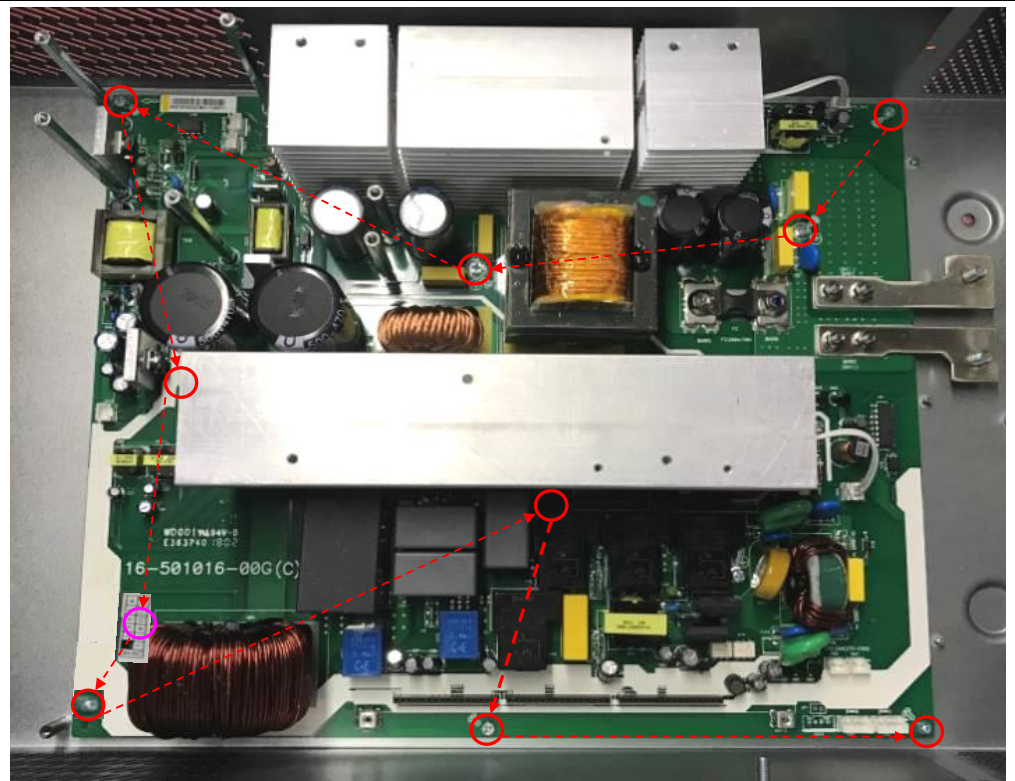

Note: When you put the new control board on the main board, please make sure that the connection is correct and tighten. Don't forget to put the screws and cables back.

5. Cables connection

AXPERT KING 5KW With MPPT Model

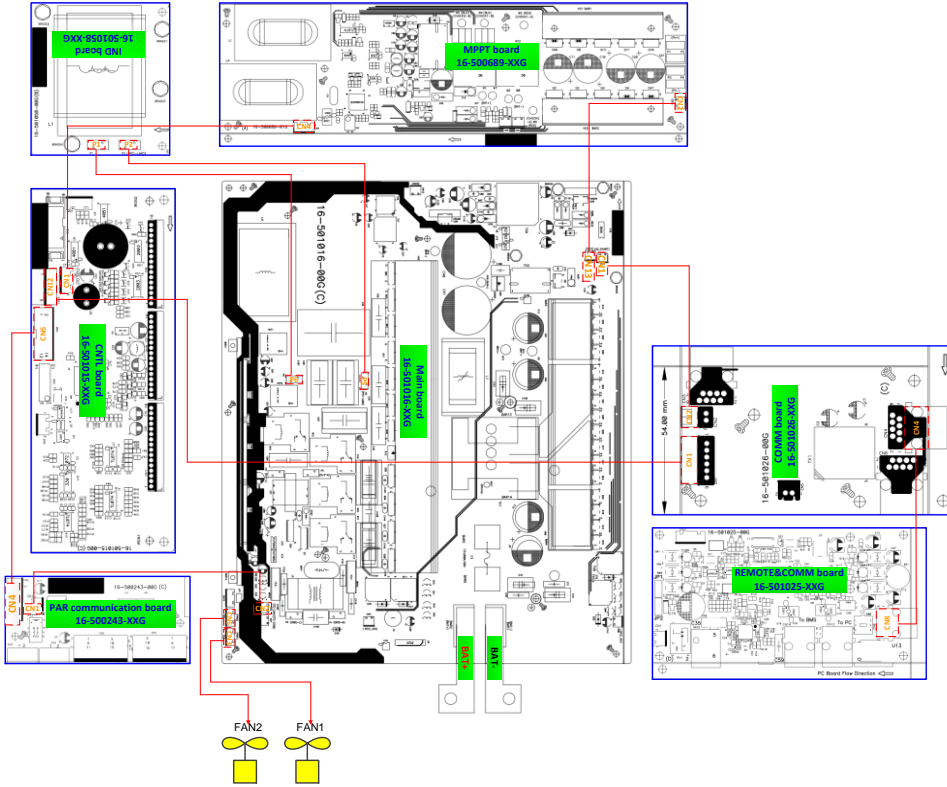

AXPERT KING 3KW With MPPT Model

